

Packard Bell EasyNote TM86/TM87/TM89 Series Service Guide

Service guide files and updates are available on the ACER/CSD web; for more information, please refer to <http://csd.acer.com.tw>

PRINTED IN TAIWAN

Revision History

Please refer to the table below for the updates made on Packard Bell EasyNote TM86/TM87/TM89 service guides.

Date	Chapter	Updates

Copyright

Copyright © 2010 by Acer Incorporated. All rights reserved. No part of this publication may be reproduced, transmitted, transcribed, stored in a retrieval system, or translated into any language or computer language, in any form or by any means, electronic, mechanical, magnetic, optical, chemical, manual or otherwise, without the prior written permission of Acer Incorporated.

Disclaimer

The information in this guide is subject to change without notice.

Acer Incorporated makes no representations or warranties, either expressed or implied, with respect to the contents hereof and specifically disclaims any warranties of merchantability or fitness for any particular purpose. Any Acer Incorporated software described in this manual is sold or licensed "as is". Should the programs prove defective following their purchase, the buyer (and not Acer Incorporated, its distributor, or its dealer) assumes the entire cost of all necessary servicing, repair, and any incidental or consequential damages resulting from any defect in the software.

Acer is a registered trademark of Acer Corporation.

Intel is a registered trademark of Intel Corporation.

Pentium and Pentium II/III are trademarks of Intel Corporation.

Other brand and product names are trademarks and/or registered trademarks of their respective holders.

Conventions

The following conventions are used in this manual:

SCREEN MESSAGES	Denotes actual messages that appear on screen.
NOTE	Gives bits and pieces of additional information related to the current topic.
WARNING	Alerts you to any damage that might result from doing or not doing specific actions.
CAUTION	Gives precautionary measures to avoid possible hardware or software problems.
IMPORTANT	Reminds you to do specific actions relevant to the accomplishment of procedures.



NOTE: This symbol where placed in the Service Guide designates a component that should be recycled according to the local regulations.

Preface

Before using this information and the product it supports, please read the following general information.

1. This Service Guide provides you with all technical information relating to the BASIC CONFIGURATION decided for Acer's "global" product offering. To better fit local market requirements and enhance product competitiveness, your regional office MAY have decided to extend the functionality of a machine (e.g. add-on card, modem, or extra memory capability). These LOCALIZED FEATURES will NOT be covered in this generic service guide. In such cases, please contact your regional offices or the responsible personnel/channel to provide you with further technical details.
2. Please note WHEN ORDERING FRU PARTS, that you should check the most up-to-date information available on your regional web or channel. If, for whatever reason, a part number change is made, it will not be noted in the printed Service Guide. For ACER-AUTHORIZED SERVICE PROVIDERS, your Acer office may have a DIFFERENT part number code to those given in the FRU list of this printed Service Guide. You MUST use the list provided by your regional Acer office to order FRU parts for repair and service of customer machines.

System Specifications	1
Features	1
System Block Diagram	5
Your Acer Notebook tour	6
Front View	6
Closed Front View	7
Left View	8
Right View	9
Bottom View	9
Indicators	10
TouchPad Basics	11
Using the Keyboard	12
Lock Keys and embedded numeric keypad	12
Windows Keys	13
Hot Keys	14
Hardware Specifications and Configurations	16
 System Utilities	 23
BIOS Setup Utility	23
Navigating the BIOS Utility	23
Packard Bell EasyNote TM86/TM87/TM89 BIOS	24
Information	24
Main	25
Security	27
Boot	30
Exit	31
BIOS Flash Utilities	32
DOS Flash Utility	33
WinFlash Utility	35
Remove HDD/BIOS Password Utilities	36
 Machine Disassembly and Replacement	 41
Disassembly Requirements	41
Pre-disassembly Instructions	42
Disassembly Process	43
External Module Disassembly Process	44
External Modules Disassembly Flowchart	44
Removing the Battery Pack	45
Removing the SIM Card	46
Removing the SD Dummy Card	47
Removing the Optical Drive Module	48
Removing the Logic Lower Door	50
Removing the 3G Module	51
Removing the DIMM Module	53
Removing the WLAN Module	54
Removing the Hard Disk Drive Module	56
Main Unit Disassembly Process	58
Main Unit Disassembly Flowchart	58
Removing the Keyboard	60
Removing the Upper Cover	62
Removing the Left Speaker Module	66
Removing the Right Speaker Module	67
Removing the Power Board	69
Removing the TouchPad Bracket	70

Table of Contents

Removing the Card Reader Board	72
Removing the USB Board	74
Removing the Bluetooth Board	76
Removing the Mainboard	77
Removing the Thermal Module	81
Removing the CPU	83
LCD Module Disassembly Process	84
LCD Module Disassembly Flowchart	84
Removing the LCD Assembly	85
Removing the LCD Bezel	88
Removing the Camera Module	89
Removing the Inverter Board	90
Removing the LCD Panel	92
Removing the LCD Brackets and FPC Cable	94
Removing the Microphone Cable	96
Removing the Antennas	98
LCD Module Reassembly Procedure	100
Replacing the Antennas	100
Replacing the Microphone Cable	102
Replacing the LCD Brackets and FPC Cable	103
Replacing the LCD Panel	105
Replacing the Inverter Board	106
Replacing the Camera Module	107
Replacing the LCD Bezel	108
Replacing the LCD Assembly	109
Main Module Reassembly Procedure	112
Replacing the CPU	112
Replacing the Thermal Module	113
Replacing the Mainboard	114
Replacing the Bluetooth Board	117
Replacing the USB Board	118
Replacing the Card Reader Board	119
Replacing the TouchPad Bracket	120
Replacing the Power Board	122
Replacing the Right Speaker Module	123
Replacing the Left Speaker Module	124
Replacing the Upper Cover	125
Replacing the Keyboard	128
Replacing the Hard Disk Drive Module	129
Replacing the WLAN Module	130
Replacing the DIMM Modules	131
Replacing the 3G Module	132
Replacing the Logic Lower Door	134
Replacing the ODD Module	135
Replacing the SD Dummy Card	136
Replacing the SIM Card	137
Replacing the Battery	138

Troubleshooting 139

Common Problems	139
Power On Issue	140
No Display Issue	141
Random Loss of BIOS Settings	142
LCD Failure	143
Built-In Keyboard Failure	143

Table of Contents

TouchPad Failure	144
Internal Speaker Failure	144
HDD Not Operating Correctly	146
ODD Failure	147
Wireless Function Failure	150
Thermal Unit Failure	150
External Mouse Failure	151
Other Failures	151
Intermittent Problems	152
Undetermined Problems	152
Post Codes	153
Jumper and Connector Locations	159
Top View	159
Bottom View	160
USB/B Board	161
Power Board	161
3G/B Board	162
CR/B Board	162
Clearing Password Check and BIOS Recovery	163
Clearing Password Check	163
Clear CMOS Jumper	163
BIOS Recovery by Crisis Disk	164
FRU (Field Replaceable Unit) List	165
EasyNote Exploded Diagrams	166
Main Assembly	166
Upper Assembly	167
LCD Assembly	168
FRU List	169
Screw List	176
Model Definition and Configuration	178
Packard Bell EasyNote TM86	179
Packard Bell EasyNote TM87	182
Packard Bell EasyNote TM89	185
Test Compatible Components	187
Microsoft® Windows® 7 Environment Test	188
Online Support Information	201
Index	203

Table of Contents

System Specifications

Features

Below is a brief summary of the computer's many features:

NOTE: Items denoted with an (*) are only available for selected models.

Operating System

- Genuine Windows® 7 Home Premium 64-bit*
- Genuine Windows® 7 Home Basic 64-bit*

Platform

- Intel® Core i5-430M/i5-520M/i5-540M processor (3 MB L3 cache, 2.26/2.40/2.53 GHz with Turbo Boost up to 2.53/2.93/3.06 GHz, 1066 MHz FSB, 35 W), supporting Intel® 64 architecture, Intel® Smart Cache*
- Intel® Core i3-330M/i3-350M processor (3 MB L3 cache, 2.13/2.26 GHz, 1066 MHz FSB, 35 W), supporting Intel® 64 architecture, Intel® Smart Cache*
- Mobile Intel® HM55 Express Chipset

System Memory

- Dual-channel DDR3 SDRAM support:
 - Up to 4 GB of DDR3 1066 MHz memory, upgradeable to 8 GB using two soDIMM modules

Display

- 15.6" HD 1366 x 768 pixel resolution, high-brightness (220-nit) TFT LCD with Diamond View Technology, supporting simultaneous multi-window viewing
- 16:9 aspect ratio
- 8 ms response time

Graphics

- ATI Mobility Radeon™ HD 5470 with up to 3579 MB of HyperMemory™ (512 MB of dedicated DDR3 VRAM, up to 3067 MB of shared system memory), supporting Unified Video Decoder (UVD), OpenEXR High Dynamic-Range (HDR) technology, Shader Model 5.0, Microsoft® DirectX® 11, OpenGL® 3.1, OpenCL™ 1.1*
- NVIDIA® GeForce® 320M6 with up to 4091 MB of TurboCache™ (1024 MB of dedicated DDR3 VRAM, up to 3067 MB of shared system memory), supporting NVIDIA® CUDA™, PhysX™, PureVideo® HD technology, OpenEXR High Dynamic-Range (HDR) technology, Shader Model 4.0, Microsoft® DirectX® 10.1*
- Intel® HD Graphics with 128 MB of dedicated system memory, supporting Microsoft® DirectX® 10*
- Dual independent display support
- 16.7 million colors

-
- External resolution / refresh rate:
 - VGA port up to 2560 x 1600: 60 Hz
 - VGA port up to 2048 x 1536: 85 Hz
 - HDMI™ port up to 1920 x 1080: 60 Hz
 - MPEG-2/DVD decoding
 - WMV9 (VC-1) and H.264 (AVC) decoding
 - Microsoft® DirectX Video Acceleration (DXVA) application interface (API)
 - HDMI™ (High-Definition Multimedia Interface) with HDCP (High-bandwidth Digital Content Protection) support

Storage subsystem

- 160/250/320/500/640 GB hard disk drive
- Multi-in-1 card reader, supporting:
 - Secure Digital™ (SD) Card, MultiMediaCard (MMC), Memory Stick™ (MS), Memory Stick PRO™ (MS PRO), xD-Picture Card™ (xD)

Audio

- Two built-in stereo speakers
- High-definition audio support
- Built-in microphone
- MS-Sound compatible

Optical Media Drive

- 4X Blu-ray Disc™/DVD-Super Multi double-layer drive*:
 - Read: 24X CD-ROM, 24X CD-R, 24X CD-RW, 8X DVD-ROM, 8X DVD-R, 8X DVD+R, 8X DVD-ROM DL, 6X DVD-R DL, 6X DVD+R DL, 8X DVD-RW, 8X DVD+RW, 5X DVD-RAM, 4X BD-ROM, 4X BD-R, 2X BD-RE, 4X BD-ROM DL, 4X BD-R DL, 2X BD-RE DL
 - Write: 24X CD-R, 16X CD-RW, 8X DVD-R, 8X DVD+R, 6X DVD-RW, 6X DVD+RW, 5X DVD-RAM, 4X DVD+R DL, 4X DVD-R DL
- 8X DVD-Super Multi double-layer drive*:
 - Read: 24X CD-ROM, 24X CD-R, 24X CD-RW, 8X DVD-ROM, 8X DVD-R, 8X DVD+R, 6X DVD-ROM DL, 6X DVD-R DL, 6X DVD+R DL, 6X DVD-RW, 6X DVD+RW, 5X DVD-RAMo
 - Write: 24X CD-R, 16X CD-RW, 8X DVD-R, 8X DVD+R, 4X DVD-R DL, 4X DVD+R DL, 6X DVD-RW, 8X DVD+RW, 5X DVD-RAM

Dimensions and Weight

- 381 (W) x 253 (D) x 26/34.14 (H) mm (14.99 x 9.96 x 1.02/1.35 inches)
- 2.65 kg (5.82 lbs.)13 with 6-cell battery

Communication

- Video conferencing solution, featuring:
 - High-def webcam with 1280 x 1024 resolution
 - Microphone
- WLAN:

-
- 802.11b/g/n Wi-Fi CERTIFIED™
 - 802.11b/g Wi-Fi CERTIFIED™
 - WPAN:
 - Bluetooth® 2.1
 - LAN:
 - Gigabit Ethernet, Wake-on-LAN ready

Privacy control

- BIOS user, supervisor, HDD passwords
- Kensington lock slot

Power subsystem

- ACPI 3.0 CPU power management standard: supports Standby and Hibernation power-saving modes
- 3-pin 90 W AC adapter*:
 - 133 (W) x 59 (D) x 31 (H) mm (5.23 x 2.32 x 1.22 inches)
 - 390 g (0.86 lbs.) with 180 cm DC cable
- 3-pin 65 W AC adapter*:
 - 108 (W) x 46 (D) x 29.5 (H) mm (4.25 x 1.81 x 1.16 inches)
 - 225 g (0.49 lbs.) with 180 cm DC cable
- 4400 mAh 6-cell Li-ion standard battery pack
- Estimated battery life: Up to 4 hours, 30 minutes with integrated graphics; up to 3 hours, 20 minutes¹⁴ with discrete graphics.
- ENERGY STAR®

Special keys and controls

- 99-/100-/103-key keyboard
- Multi-gesture touchpad, supporting two-finger scroll, pinch, rotate, flip
- Nine function keys, four cursor keys, Windows® key, international language support

I/O interface

- Multi-in-1 card reader
- Three USB 2.0 ports
- HDMI™ port with HDCP support
- External display (VGA) port
- Headphone/speaker/line-out jacks
- Microphone-in jack
- Ethernet (RJ-45) port
- DC-in jack for AC adapter

Software

- Packard Bell Accessory Store (Canada, France, Germany, Italy, Mexico, Spain UK, US only)

-
- Packard Bell Identity Card
 - Packard Bell InfoCentre
 - Packard Bell MyBackup Solution
 - Packard Bell Power Management
 - Packard Bell Recovery Management
 - Packard Bell Registration
 - Packard Bell Social Networking Application
 - Packard Bell Updater
 - Adobe® Flash® Player 10
 - Adobe® Photoshop® Elements 7
 - Adobe® Reader® 9.1
 - Cyberlink® PowerDVD™
 - eBay® shortcut 2009 (Belgium, France, Germany, Italy, Netherlands, Spain, Sweden, UK only)
 - Google Toolbar™
 - Metaboli
 - Microsoft® Office Trial (Service Pack 2)
 - Microsoft® Silverlight™
 - Microsoft® Works SE 9 (Brazil, Canada, France, Germany, Poland, Russia, UK and US only)
 - Microsoft® Works 9
 - Nero® 9 Essentials Packard Bell Edition
 - Norton Internet Security™ 2010 Packard Bell Edition
 - WildTangent® Packard Bell Edition (except China, Japan, Hong Kong, Korea)
 - Windows Live™ Essentials - Wave 3.2 (Mail, Photo Gallery, Live™ Messenger, Movie Maker, Writer)

Optional Items

- Bluetooth® 2.1 module
- 1 GB / 2 GB / 4 GB DDR3 1333 MHz soDIMM module
- 4400 mAh 6-cell Li-ion battery pack
- 3-pin 90 W AC adapter*
- 3-pin 65 W AC adapter*

Environment

- Temperature:
 - Operating: 5 °C to 35 °C
 - Non-operating: -20 °C to 65 °C
- Humidity (non-condensing):
 - Operating: 20% to 80%
 - Non-operating: 20% to 80%

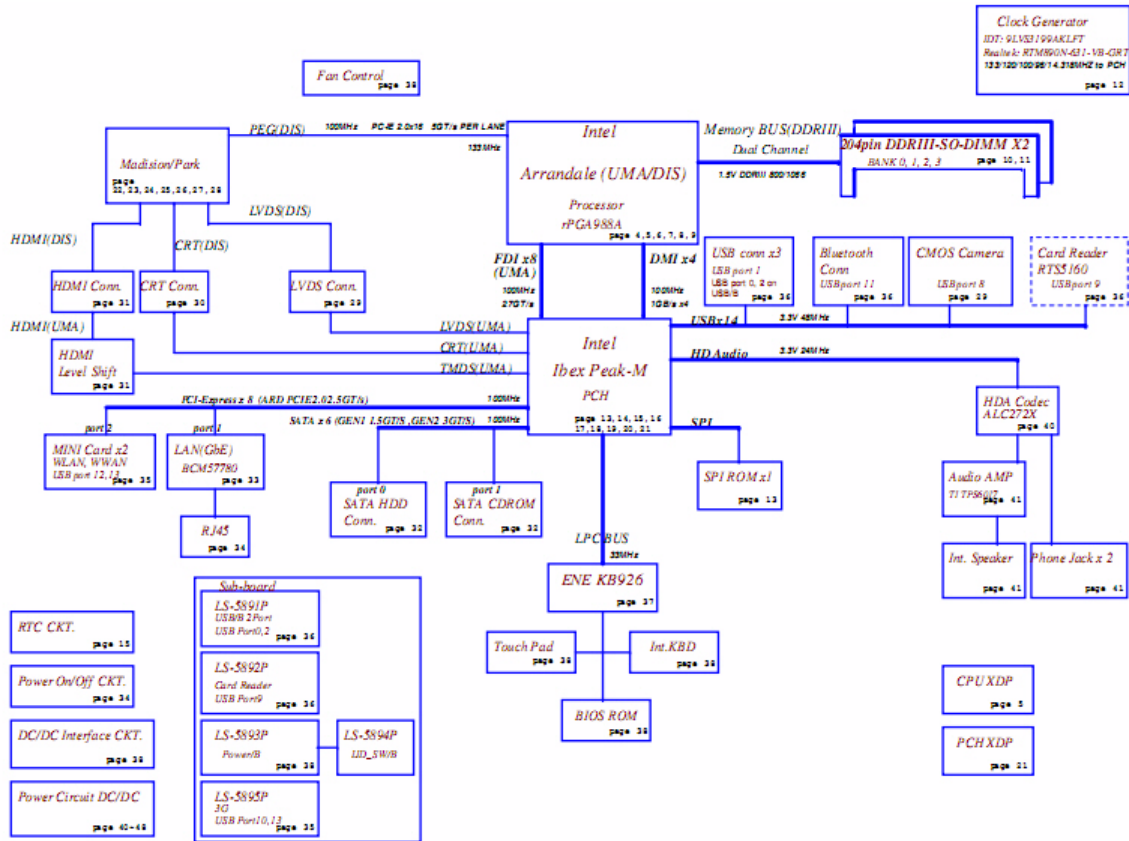

System Block Diagram



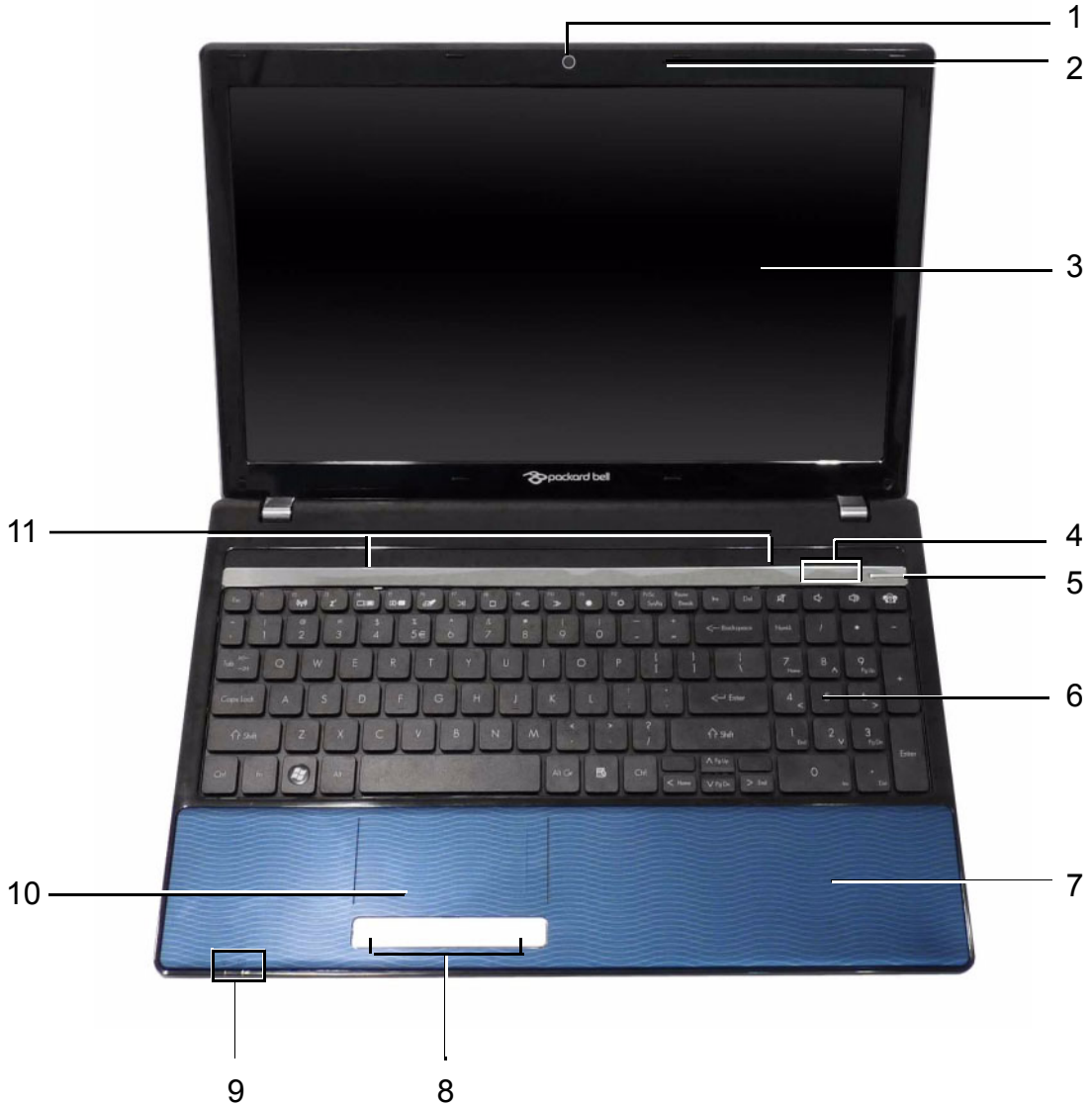

Your Acer Notebook tour

Front View



No.	Icon	Item	Description
1		Webcam	Web camera for video communication (for selected models).
2		Microphone	Internal microphone for recording sound.
3		Display screen	Also called Liquid-Crystal Display (LCD), displays computer output.
4		HDD	Indicates when the hard disk drive is active.
		Communication indicator	Indicates the computer's wireless connectivity device status.

No.	Icon	Item	Description
5		Power button	Turns the computer on and off.
6		Keyboard	For entering data into your computer.
7		Palmrest	Comfortable support area for your hands when you use the computer.
8		Click buttons (left and right)	The left and right buttons function like the left and right mouse buttons.
9		Power ¹	Indicates the computer's power status.
		Battery ¹	Indicates the computer's battery status. 1. Charging: The light shows amber when the battery is charging. 2. Fully charged: The light shows blue when in AC mode.
10		TouchPad	Touch-sensitive pointing device which functions like a computer mouse.
11		Speakers	Left and right speakers deliver stereo audio output.

NOTE: ¹ The front panel indicators are visible even when the computer cover is closed.







Closed Front View

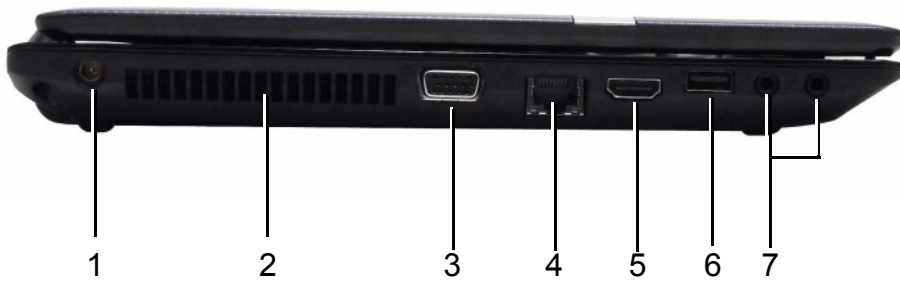

No.	Icon	Item	Description
1		Multi-in-1 card reader	Accepts Secure Digital (SD), MultiMediaCard (MMC), Memory Stick (MS), Memory Stick PRO (MS PRO), xDPicture Card (xD). NOTE: Push to remove/install the card. Only one card can operate at any given time.



Left View



No.	Icon	Item	Description
1		DC-in jack	Connects to an AC adapter
2		Ventilation slots	Enable the computer to stay cool, even after prolonged use.
3		External display (VGA) port	Connects to a display device (e.g. external monitor, LCD projector).
4		Ethernet (RJ-45) port	Connects to an Ethernet 10/100-based network.
5		HDMI	Connect to HDMI devices
6		USB 2.0 ports	Connect to USB 2.0 devices (e.g. USB mouse, USB camera).
7		Microphone-in jack	Accepts input from external microphones.
		Headphones/speaker/line-out jack	Connects to audio line-out devices (e.g. speakers, headphones).

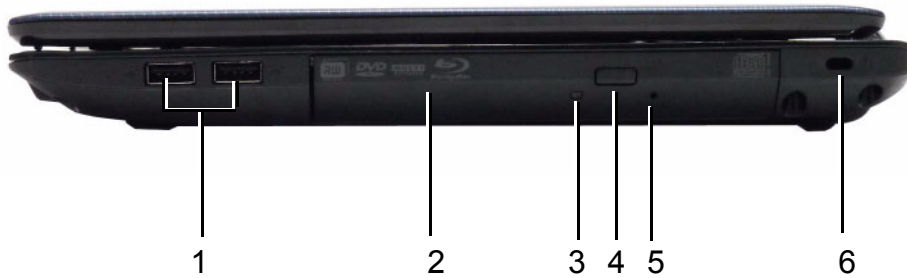

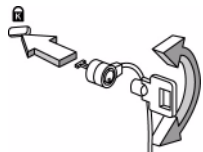

Right View

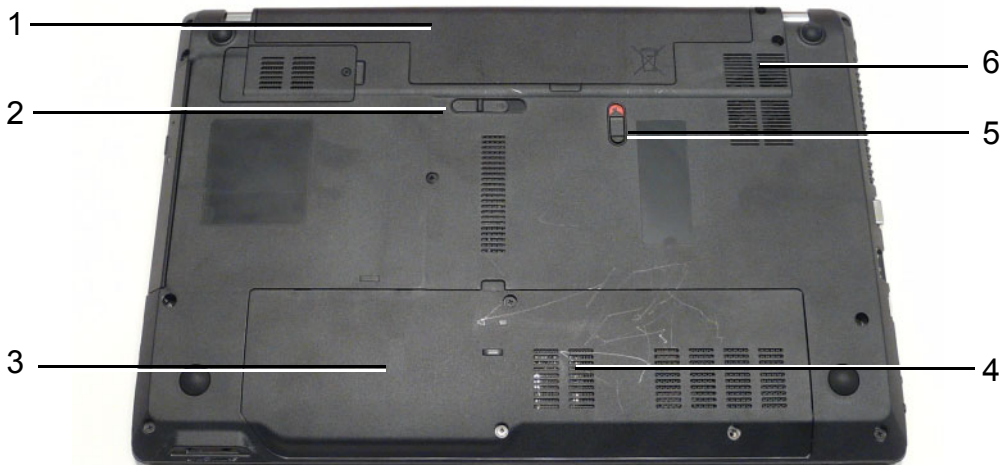

No.	Item	Description	
1		USB 2.0 ports	Connect to USB 2.0 devices (e.g. USB mouse, USB camera).
2		Optical drive	Internal optical drive; accepts CDs or DVDs.
3		Optical disk access indicator	Lights up when the optical drive is active.
4		Optical drive eject button	Ejects the optical disk from the drive.
5		Emergency eject hole	Ejects the optical drive tray when the computer is turned off. Note: Insert a paper clip into the emergency eject hole to eject the optical drive tray when the computer is off.
6		Kensington lock slot 	Connects to a Kensington-compatible computer security lock. Note: Wrap the computer security lock cable around an immovable object such as a table or handle of a locked drawer. Insert the lock into the notch and turn the key to secure the lock. Some keyless models are also available.





Bottom View



No.	Icon	Item	Description
1		Battery bay	Houses the computer's battery pack.
2		Battery release latch	Releases the battery for removal.
3		Hard disk bay	Houses the computer's hard disk (secured with screws).
4		Memory compartment	Houses the computer's main memory.
5		Battery lock	Locks the battery in position.
6		Ventilation slots and cooling fan	Enable the computer to stay cool, even after prolonged use. Note: Do not cover or obstruct the fan opening.

Indicators

The computer has several easy-to-read status indicators. The front panel indicators are visible even when the computer cover is closed.

Icon	Function	Description
	Power	Indicates the computer's power status.
	Battery	Indicates the computer's battery status. NOTE: 1. Charging: The light shows amber when the battery is charging. 2. Fully charged: The light shows green when in AC mode.
	HDD	Indicates when the hard disk drive is active.
	Communication indicator	Indicates the computer's wireless connectivity device status.

TouchPad Basics

The following items show you how to use the TouchPad:

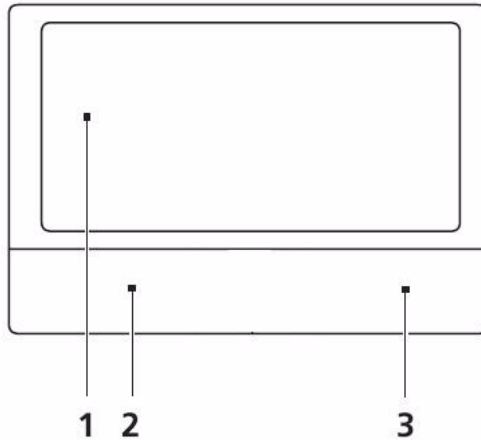

- Move your finger across the TouchPad (1) to move the cursor.
- Press the left (2) and right (3) buttons located beneath the TouchPad to perform selection and execution functions. These two buttons are similar to the left and right buttons on a mouse. Tapping on the TouchPad is the same as clicking the left button.

Function	Left Button (2)	Right Button (3)	Main TouchPad (1)
Execute	Quickly click twice.		Tap twice (at the same speed as double-clicking a mouse button).
Select	Click once.		Tap once.
Drag	Click and hold, then use finger on the TouchPad to drag the cursor.		Tap twice (at the same speed as double-clicking a mouse button); rest your finger on the TouchPad on the second tap and drag the cursor.
Access context menu		Click once.	

NOTE: When using the TouchPad, keep it - and your fingers - dry and clean. The TouchPad is sensitive to finger movement; hence, the lighter the touch, the better the response. Tapping too hard will not increase the TouchPad's responsiveness.

Using the Keyboard

The keyboard has full-sized keys and an embedded numeric keypad, separate cursor, lock, Windows, function and special keys.

Lock Keys and embedded numeric keypad



















The keyboard has two lock keys which you can toggle on and off.



Lock key	Description
Caps Lock	When Caps Lock is on, all alphabetic characters typed are in uppercase.
Num Lock	When Num Lock is on, the embedded keypad is in numeric mode.

Windows Keys

The keyboard has two keys that perform Windows-specific functions.

Key	Description
 Windows key	<p>Pressed alone, this key has the same effect as clicking on the Windows Start button; it launches the Start menu. It can also be used with other keys to provide a variety of functions:</p> <ul style="list-style-type: none"> <  >: Open or close the Start menu <  > + <D>: Display the desktop <  > + <E>: Open Windows Explore <  > + <F>: Search for a file or folder <  > + <G>: Cycle through Sidebar gadgets <  > + <L>: Lock your computer (if you are connected to a network domain), or switch users (if you're not connected to a network domain) <  > + <M>: Minimizes all windows <  > + <R>: Open the Run dialog box <  > + <T>: Cycle through programs on the taskbar <  > + <U>: Open Ease of Access Center <  > + <X>: Open Windows Mobility Center <  > + <BREAK>: Display the System Properties dialog box <  > + <SHIFT+M>: Restore minimized windows to the desktop <  > + <TAB>: Cycle through programs on the taskbar by using Windows Flip 3-D <  > + <SPACEBAR>: Bring all gadgets to the front and select Windows Sidebar <CTRL> + <  > + <F>: Search for computers (if you are on a network) <CTRL> + <  > + <TAB>: Use the arrow keys to cycle through programs on the taskbar by using Windows Flip 3-D <p>Note: Depending on your edition of Windows 7, some shortcuts may not function as described.</p>
 Application key	<p>This key has the same effect as clicking the right mouse button; it opens the application's context menu.</p>



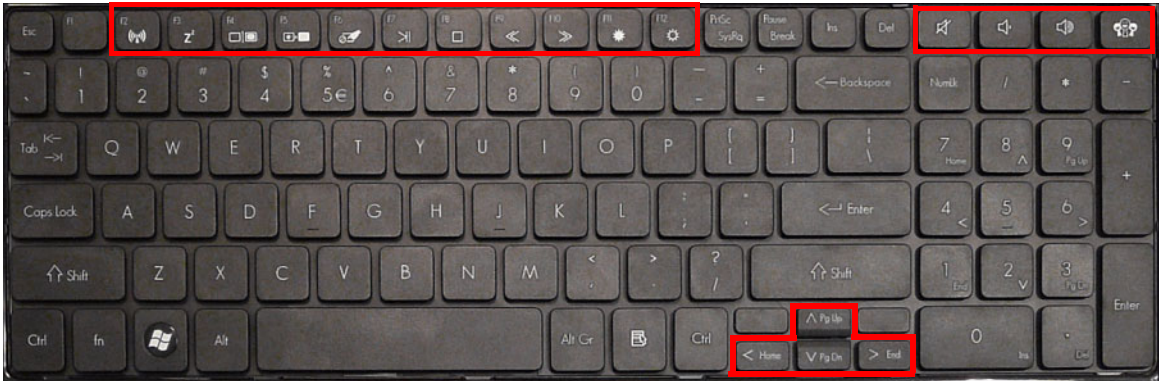

Hot Keys

The computer employs hotkeys or key combinations to access most of the computer's controls like screen brightness, volume output and the BIOS utility.

To activate hot keys, press and hold the <Fn> key before pressing the other key in the hotkey combination.



Hotkey	Icon	Function	Description
<Fn> + <F2>		Communication Device On/Off	Toggles WiFi, 3G and Bluetooth on and off using a pop-up window.
<Fn> + <F3>		Sleep	Puts the computer in Sleep mode.
<Fn> + <F4>		Display toggle	Switches display output between the display screen, external monitor (if connected) and both.
<Fn> + <F5>		Display Blank	Turns off the LCD back light
<Fn> + <F6>		Touchpad toggle	Turns the touchpad on and off.
<Fn> + <F7>		Play/Pause	Toggles media between play and pause.
<Fn> + <F8>		Stop	Stops media playback.
<Fn> + <F9>		Skip Back	Skips media backward.
<Fn> + <F10>		Skip Forward	Skips media forward.
<Fn> + <F11>		Brightness Down	Decreases the screen brightness.
<Fn> + <F12>		Brightness Up	Increases the screen brightness.
		Speaker toggle	Turns the speakers on and off.
		Volume down	Decreases the sound volume.
		Volume up	Increases the sound volume.

Hotkey	Icon	Function	Description
		Social Networking	Opens Facebook Login screen.
<Fn> + <Pg Up>		Page Up	Scrolls the page up.
<Fn> + <Pg Dn>		Page Down	Scrolls the page down.
<Fn> + <Home>		Home	Scrolls to the top of the page.
<Fn> + <End>		End	Scrolls to the bottom of the page.

Hardware Specifications and Configurations

Processor

Item	Specification
CPU	<ul style="list-style-type: none"> Intel Calpella (Discrete/UMA: Arrandale with Gfx) Intel PCH: HM55 (4MB SPI ROM)
Type	Intel Mobile Memron uPGA
CPU Package	Micro uPGA-478 Package
Power	65 Watts
On-die Cache	4MB L2 cache
Front Side Bus	667/800/1066MHz

Processor Specifications

Item	CPU Speed	Cores	Bus Speed	Cache Size	Package	Core Voltage	Acer P/N
Ci3330M	2.13	2	330 M	3 MB	PGA988	35W	KC.33001.DMP
Ci5430M	2.26	2	430 M	3 MB	PGA988	35W	KC.43001.DMP
Ci5520M	2.24	2	520 M	3 MB	PGA988P	35W	KC.52001.DMP

CPU Fan True Value Table (Tj = 90)

CPU Temp (°C) Core 0	CPU Temp (°C) Core 1	Fan Speed (rpm)	SPL Spec (dBA)
45	57	2300	28
52	64	3000	31
59	70	3100	34
65	78	3500	37
72	85	3900	40

- Throttling 50%: On=85°C, Off=72°C
- OS Shutdown: 104°C
- H/W Shutdown: 92°C

CPU Fan True Value Table (Tj = 105)

CPU Temp (°C) Core 0	CPU Temp (°C) Core 1	Fan Speed (rpm)	SPL Spec (dBA)
45	60	2300	28
55	70	3000	31
65	80	3100	34
75	90	3500	37
85	100	3900	40

- Throttling 50%: On=100°C, Off=85°C
- OS Shutdown: 104°C
- H/W Shutdown: 92°C

BIOS

Item	Specification
BIOS vendor	Insyde BIOS
BIOS ROM type	Flash

Item	Specification
Features	<ul style="list-style-type: none"> Flash ROM 4MB Support ISIPP Support Acer UI Support multi-boot Suspend to RAM (S3)/Disk (S4) Various hot-keys for system control Support SMBIOS 2.3, PCI2.2. Refer to Acer BIOS specification. DMI utility for BIOS serial number configurable/asset tag Support PXE Support Y2K solution Support WinFlash Wake on LAN from S3 Wake on LAN form S4 in AC mode System information

System Memory

Item	Specification
Memory size	8GB maximum
DIMM socket number	2
Supports memory size per socket	4GB
Supports DIMM type	204-pin +1.5V DDRIII
Supports DIMM Speed	800/1066 MHz
Supports DIMM voltage	1.5V

Memory Combinations

Slot 1	Slot 2	Total Memory
0MB	1024MB	1024MB
0MB	2048MB	2048MB
0MB	4096MB	4096MB
1024MB	0MB	1024MB
1024MB	1024MB	2048MB
1024MB	2048MB	3072MB
2048MB	0MB	2048MB
2048MB	1024MB	3072MB
2048MB	2048MB	4096MB
2048MB	4096MB	6144MB
4096MB	4096MB	8192MB

NOTE: Above table lists some system memory configurations. You may combine DIMMs with various capacities to form other combinations. In the above table, the configuration of slot 1 and slot 2 could be reversed.

LAN Interface

Item	Specification
LAN Chipset	Atheros AR8132L
LAN connector type	RJ-45
LAN connector location	Left side

Item	Specification
Feature	Support for 10/100/1000

Onboard LAN

Item	Specification
Manufacturer	Broadcom 57780KMLG for GIGA LAN <ul style="list-style-type: none"> • Integrated 10/100/1000BASE-T transceiver • Automatic MDI crossover function • PCIe V1.1 compliant • 10/100/1000BASE-T full -duplex/half -duplex MAC • Receive side scaling(RSS) for multicore processors • Complies with IEEE 802.3, 802.3u, 802.3ab, and 802.1p • Wake on LAN (WOL) support meeting the ACPI requirements • Statistics for SNMP MIB II, Ethernet-like MIB, and Ethernet MIB (IEEE 802.3z, Clause 30) • Self-boot feature, utilizing smaller EEPROM size with ability to use on-chip memory • Supports iSCSI boot • PCI Express CLKREQ support • Integrated switching regulator for improved power consumption • IPv4 and IPv6 large sendoffload and checksum offload (LSO/TCO)

Hard Disk Drive Interface

Item	Specification			
Vendor & Model Name	Seagate	HGST	Toshiba	Western Digital
Capacity (MB)	160, 250, 320, 500	160, 250, 320, 500	160, 250, 320, 500	160, 250, 320, 500, 640
Bytes per sector	512			
Data heads	2-4			
Drive Format				
Disks	1-2			
Spindle speed (RPM)	5400			
Performance Specifications				
Buffer size	8 MB			
Interface	SATA			
DC Power Requirements				
Voltage tolerance	5V \pm 5%	5V \pm 5%	5V \pm 5%	5V \pm 5%

Super-Multi Drive Module

Item	Specification			
Vendor & model name	HLDS GT20N		Sony AD7580S	
Performance Specification	With CD Diskette	With DVD Diskette	With CD Diskette	With DVD Diskette
Transfer rate (MB/sec)	Sustained: 3,600 KB/s (24x) max.	Sustained: 11.08 Mbytes/s (8x) max.	Sustained: 1,571 (typical)	Sustained: 10,993 (typical)
Buffer Memory	2 MB			
Interface	SATA			
Applicable disc formats	DVD-ROM: 4.7GB (Single Layer) 8.5GB (Dual Layer) DVD-R: 3.95GB (Ver. 1.0: read only) 4.7GB (Ver. 2.0 for Authoring: read only) 4.7GB (Ver. 2.1 for General: read & write) (DL) 8.5GB (Ver. 3.0) DVD-RW: 4.7GB (Ver. 1.2/ Rev 1.0, 2.0, 3.0) DVD-RAM: 1.46GB/side, 4.7GB/side (Ver. 2.2) DVD+R: 4.7GB (Ver. 1.3) (DL) 8.5GB (Ver. 1.1) DVD+RW: 4.7GB (Vol.1 Ver.1.3) CD-ROM Mode-1 data disc CD-ROM Mode-2 data disc CD-ROM XA, CD-I, Photo-CD Multi-Session, Video CD CD-Audio Disc Mixed mode CD-ROM disc (data and audio) CD-Extra CD-Text CD-R (Conforming to "Orange Book Part 2": read & write) CD-RW (Conforming to "Orange Book Part 3": read & write)		DVD Read: DVD-ROM (DVD-5, DVD-9, DVD-10, DVD-18), DVD-Video, DVD-Audio, SACD (Hybrid), UDF DVD, DVD-R, DVD-R DL, DVD-R 3.95 GB, DVD-R Authoring, DVD-R Multi-Border, DVD-RW, DVD+R, DVD+R DL, DVD+R Multi-Session, DVD+RW, DVD-RAM V1.0, DVDRAM V2.0 & 2.1 & 2.2. CD Read: CD-DA, CD-ROM Mode-1, CD-ROM/XA Mode-2 Form-1 and Mode-2 Form-2, CD-i, CD-i Bridge, Video-CD (MPEG-1), Karaoke CD, Photo-CD, Enhanced CD, CD Plus, CD Extra, itrax CD, CD-Text, UDF CD, CD-R, and CD-RW DVD Write: DVD Data & Video CD Read: CD-DA, CD-ROM Mode-1, CD-ROM/XA Mode-2 Form-1 and Mode-2 Form-2, CD-i, Video- CD, CD-Text	
Loading mechanism	Drawer (Solenoid Open) Tact SW (Open) Emergency Release (draw open hole)			
Power Requirement				
Input Voltage	DC 5 V +/- 5%			

Audio Interface

Item	Specification
Chipset	Realtek ALC272-X

Item	Specification
Features	<ul style="list-style-type: none"> • High Definition Audio Codec • Single Analogue MIC • 2.0 Watt speaker/5cc chamber/speaker size 18 phi, x2 • Headphone-out w/o SPDIF-out

Power and Keyboard Controller

Item	Specification
Controller	GP8T Type; 358.27mm x 113.44mm x 4.9mm
Features	<ul style="list-style-type: none"> • Support Windows keys and Application keys • Standard pitch, 2.5 mm travel length • Multi-Language support
Hotkeys	See "Hot Keys" on page 14.

Battery

Item	Specification
	6 Cell
Vendor & model name	SANYO/SONY/PANASONIC/SAMSUNG/SIMPLO AS2009A
Battery Type	Li-ion
Pack capacity	4400 mAh
Normal Voltage	2.2 Ah
Package configuration	3S2P

LCD 15.6"

Item	Specification
Vendor/model name	AUO/CPT/CMO/Samsung/LCD/INL
Screen Diagonal (mm)	15.6 inches
Display resolution (pixels)	1366 x 768 WXGA Clare
Pixel Pitch	0.204 x 0.204
Display Mode	Normal
Typical White Luminance (cd/m ²) (also called Brightness)	220
Contrast Ratio	500 typical
Response Time (Optical Rise Time/Fall Time) msec	8
Luminance Uniformity	1.25 max
Electrical Interface	LVDS
Support Color	262K
Viewing Angle (up/down/right/ left)	15/35/45/45
Temperature Range (°C) Operating Storage (shipping)	0 to +50 -20 to +60

Card Reader

Item	Specification
Part Name	RealTek 5160
Package	5-in-1 card reader
General Features	<ul style="list-style-type: none"> • PCI-E interface • Push-push type • Dummy arø

System Utilities

BIOS Setup Utility

The BIOS Setup Utility is a hardware configuration program built into your computer's BIOS (Basic Input/Output System).

Your computer is already properly configured and optimized, and you do not need to run this utility. However, if you encounter configuration problems, you may need to run Setup. Please also refer to Chapter 4 Troubleshooting when problem arises.

To activate the BIOS Utility, press **F2** during POST (when "Press <F2> to enter Setup" message is prompted on the bottom of screen).

The default parameter of F12 Boot Menu is set to "disabled". If you want to change boot device without entering BIOS Setup Utility, please set the parameter to "enabled".

Press <F12> during POST to enter multi-boot menu. In this menu, user can change boot device without entering BIOS SETUP Utility.

Navigating the BIOS Utility

There are six menu options: Information, Main, Security, Boot, and Exit.

Follow these instructions:

- To choose a menu, use the left and right arrow keys.
- To choose an item, use the up and down arrow keys.
- To change the value of a parameter, press **F5** or **F6**.
- Press **Esc** while you are in any of the menu options to go to the Exit menu.
- In any menu, you can load default settings by pressing **F9**. You can also press **F10** to save any changes made and exit the BIOS Setup Utility.

NOTE: You can change the value of a parameter if it is enclosed in square brackets. Navigation keys for a particular menu are shown on the bottom of the screen. Help for parameters are found in the Item Specific Help part of the screen. Read this carefully when making changes to parameter values. **Please note that system information is subject to different models.**

Packard Bell EasyNote TM86/TM87/TM89 BIOS

Information

The Information screen displays a summary of the computer hardware information.

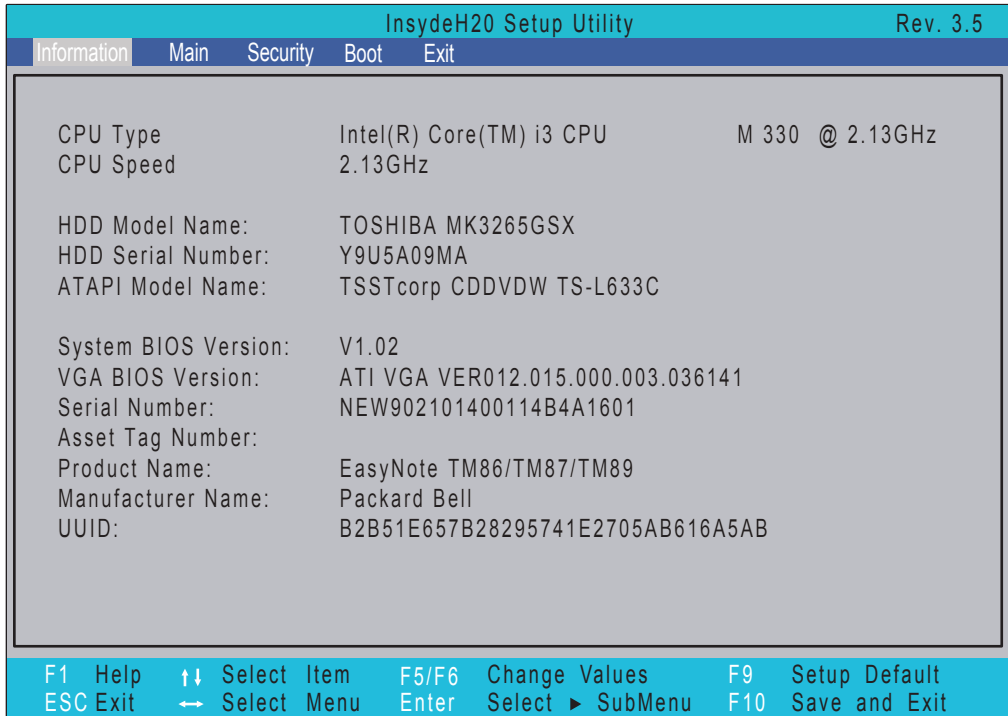

NOTE: The screen above is for your reference only. Actual values may differ according to model.

The table below describes the parameters in this screen.

Parameter	Description
CPU Type	This field shows the CPU type and speed of the system.
CPU Speed	This field shows the speed of the CPU.
HDD Model Name	This field shows the model name of HDD installed on primary IDE master.
HDD Serial Number	This field displays the serial number of HDD installed on primary IDE master.
ATAPI Model Name	This field shows the model name of the Optical device installed in the system.
System BIOS Version	Displays system BIOS version.
VGA BIOS Version	This field displays the VGA firmware version of the system.
Serial Number	This field displays the serial number of this unit.
Asset Tag Number	This field displays the asset tag number of the system.
Product Name	This field shows product name of the system.
Manufacturer Name	This field displays the manufacturer of this system.
UUID	Universally Unique Identifier (UUID) is an identifier standard used in software construction, standardized by the Open Software Foundation (OSF) as part of the Distributed Computing Environment (DCE).

Main

The Main screen allows the user to set the system time and date as well as enable and disable boot options and recovery.

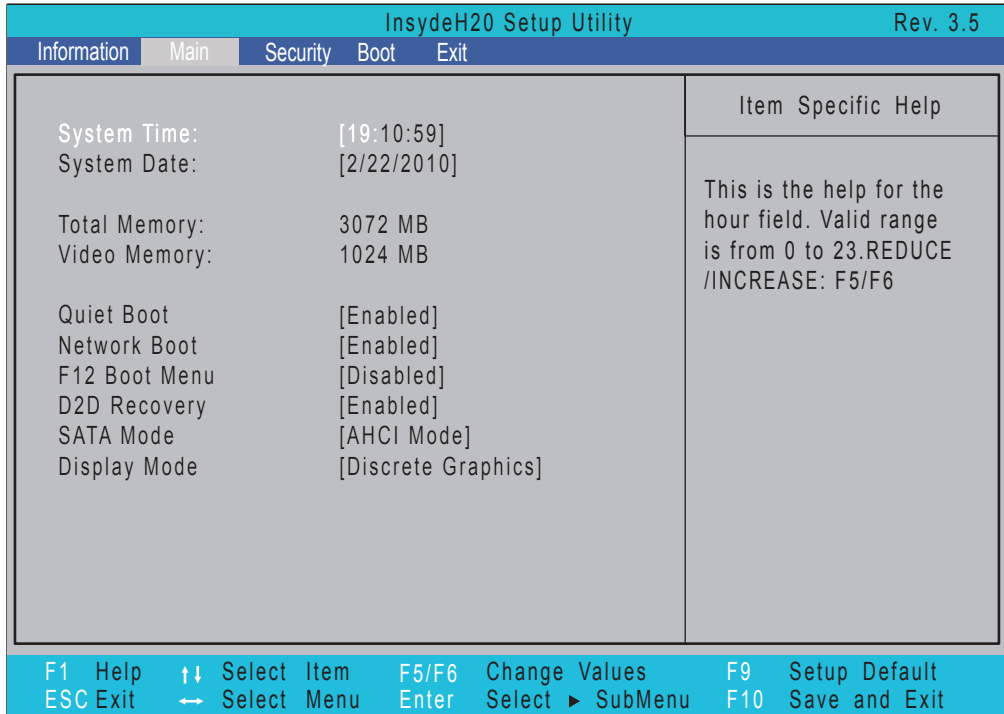

NOTE: The screen above is for your reference only. Actual values may differ.

The table below describes the parameters in this screen.

Parameter	Description	Format/Option
System Time	Sets the system time. The hours are displayed with 24-hour format.	Format: HH:MM:SS (hour:minute:second)
System Date	Sets the system date.	Format MM/DD/YYYY (month/day/year)
Total Memory	Displays the total memory available.	N/A
Video Memory	Displays the available memory for Video.	N/A
Quiet Boot	The notebook displays an illustration called the OEM screen during system boot instead of the traditional POST screen that displays the normal diagnostic messages.	Option: Enabled or Disabled
Network Boot	Enables, disables the system boot from LAN (remote server).	Option: Enabled or Disabled
F12 Boot Menu	Enables, disables Boot Menu during POST.	Option: Enabled or Enabled
D2D Recovery	Enables, disables D2D Recovery function. The function allows the user to create a hidden partition on hard disc drive to store operation system and restore the system to factory defaults.	Option: Enabled or Disabled
SATA Mode	Control the mode in which the SATA controller should operate.	Option: AHCI Mode or IDE Mode

Parameter	Description	Format/Option
Display Mode	Control the graphics display mode. Note: Switchable Graphics is displayed as an option if supported by the system.	Options: Integrated Graphics, Discrete Graphics or Switchable Graphics

Security

The Security screen contains parameters that help safeguard and protect your computer from unauthorized use.

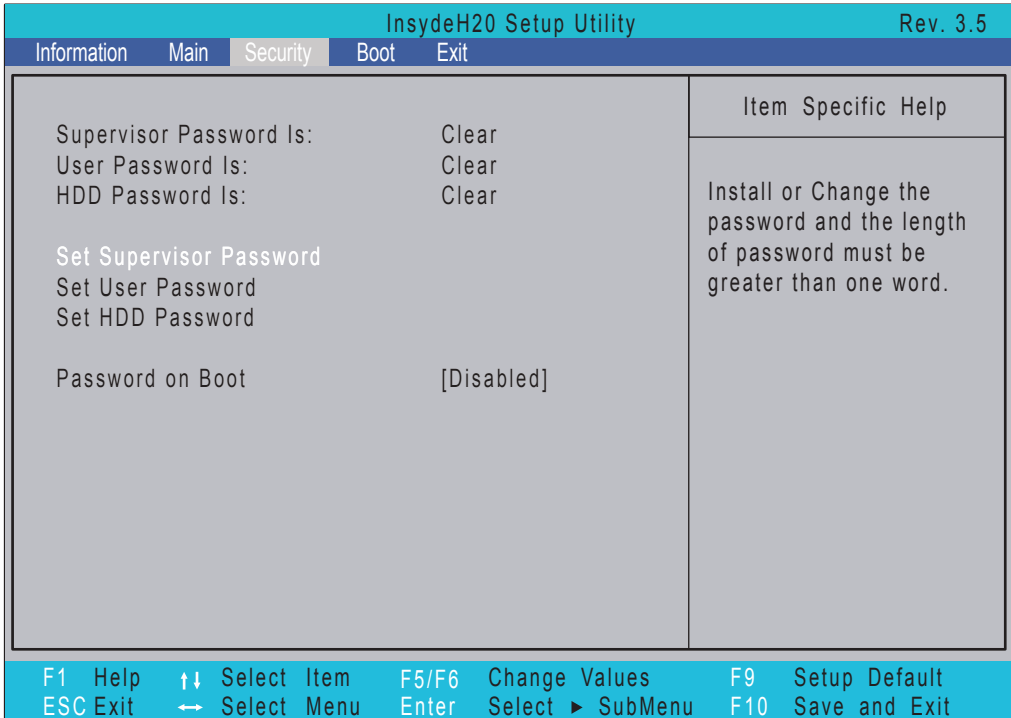

The table below describes the parameters in this screen. Settings in **boldface** are the default and suggested parameter settings.

Parameter	Description	Option
Supervisor Password Is	Shows the setting of the Supervisor password	Clear or Set
User Password Is	Shows the setting of the user password.	Clear or Set
HDD Password Is	Shows the setting of the hard disk password.	Clear or Set
Set Supervisor Password	Press Enter to set the supervisor password. When set, this password protects the BIOS Setup Utility from unauthorized access. The user can not either enter the Setup menu nor change the value of parameters.	N/A
Set User Password	Press Enter to set the user password. When user password is set, this password protects the BIOS Setup Utility from unauthorized access. The user can enter Setup menu only and does not have right to change the value of parameters.	N/A
Set HDD Password	Enter HDD Password.	N/A
Password on Boot	Defines whether a password is required or not while the events defined in this group happened. The following sub-options are all requires the Supervisor password for changes and should be grayed out if the user password was used to enter setup.	Disabled or Enabled

NOTE: When you are prompted to enter a password, you have three tries before the system halts. Don't forget your password. If you forget your password, you may have to return your notebook computer to your dealer to reset it.

Setting a Password

Follow these steps as you set the user or the supervisor password:

1. Use the ↑ and ↓ keys to highlight the Set Supervisor Password parameter and press the **Enter** key. The Set Supervisor Password box appears:

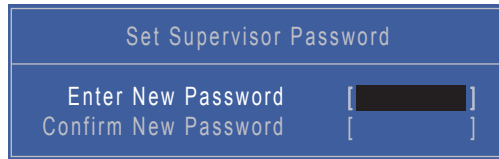

Set Supervisor Password	
Enter New Password	[REDACTED]
Confirm New Password	[REDACTED]

2. Type a password in the “Enter New Password” field. The password length can not exceed 8 alphanumeric characters (A-Z, a-z, 0-9, not case sensitive). Retype the password in the “Confirm New Password” field.

IMPORTANT: Be very careful when typing your password because the characters do not appear on the screen.

3. Press **Enter**. After setting the password, the computer sets the User Password parameter to “Set”.
4. If desired, you can opt to enable the Password on boot parameter.
5. When you are done, press F10 to save the changes and exit the BIOS Setup Utility.

Removing a Password

Follow these steps:

1. Use the ↑ and ↓ keys to highlight the Set Supervisor Password parameter and press the **Enter** key. The Set Password box appears:



Set Supervisor Password	
Enter Current Password	[REDACTED]
Enter New Password	[REDACTED]
Confirm New Password	[REDACTED]

2. Type the current password in the Enter Current Password field and press **Enter**.
3. Press **Enter** twice **without** typing anything in the Enter New Password and Confirm New Password fields. The computer then sets the Supervisor Password parameter to “Clear”.
4. When you have changed the settings, press u to save the changes and exit the BIOS Setup Utility.

Changing a Password

1. Use the ↑ and ↓ keys to highlight the Set Supervisor Password parameter and press the **Enter** key. The Set Password box appears.



The screenshot shows a blue-themed BIOS screen titled "Set Supervisor Password". It contains three input fields: "Enter Current Password" with a blacked-out field, "Enter New Password" with an empty field, and "Confirm New Password" with an empty field. Each field is followed by a pair of square brackets [] indicating the input area.

2. Type the current password in the Enter Current Password field and press **Enter**.
3. Type a password in the Enter New Password field. Retype the password in the Confirm New Password field.
4. Press **Enter**. After setting the password, the computer sets the User Password parameter to "Set".
5. If desired, you can enable the Password on boot parameter.
6. When you are done, press F10 to save the changes and exit the BIOS Setup Utility.

If the verification is OK, the screen will display as following.



The screenshot shows a white-themed BIOS screen titled "Setup Notice". The text "Changes have been saved." is displayed in the center. Below the text is a black button with the word "Continue" in white.

The password setting is complete after the user presses **Enter**.

If the current password entered does not match the actual current password, the screen will show you the Setup Warning.

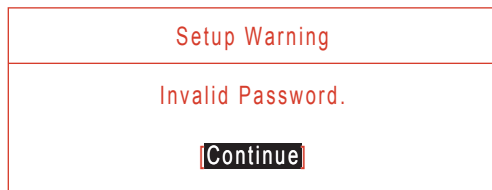

The screenshot shows a white-themed BIOS screen titled "Setup Warning" in red text. Below the title, the text "Invalid Password." is displayed in red. At the bottom, there is a black button with the word "Continue" in white.

If the new password and confirm new password strings do not match, the screen will display the following message.



The screenshot shows a white-themed BIOS screen titled "Setup Warning" in red text. Below the title, the text "Passwords do not match. Re-enter password." is displayed in red. At the bottom, there is a black button with the word "Continue" in white.

Boot

This menu allows the user to decide the order of boot devices to load the operating system. Bootable devices includes the USB diskette drives, the onboard hard disk drive and the DVD drive in the module bay.

Select Boot Devices to select specific devices to support boot.

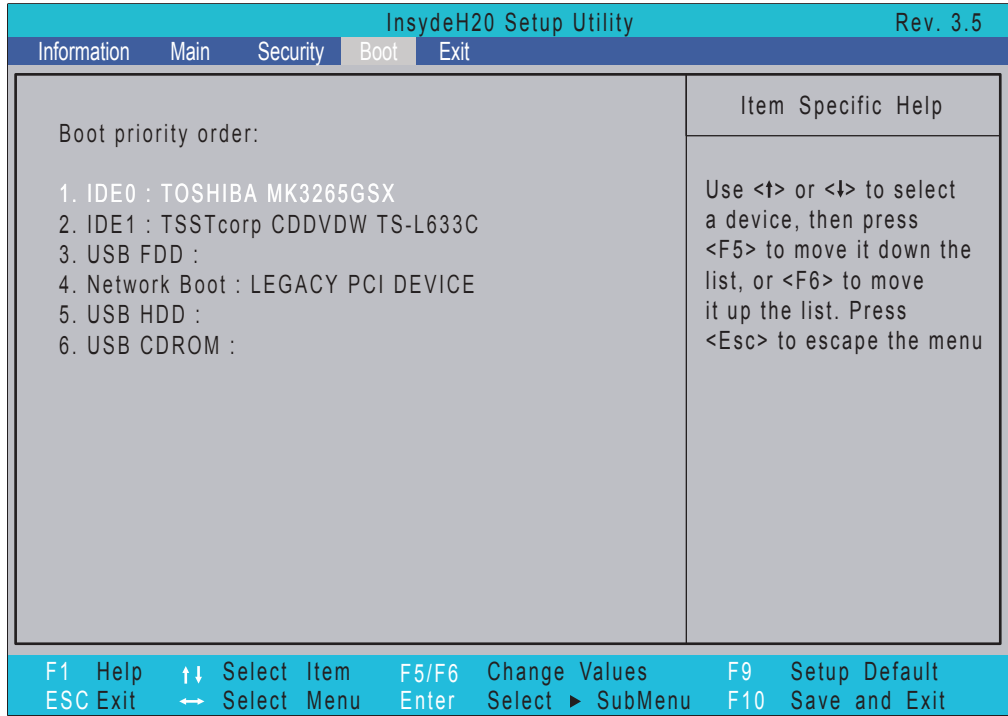

Exit

The Exit screen allows you to save or discard any changes you made and quit the BIOS Utility.

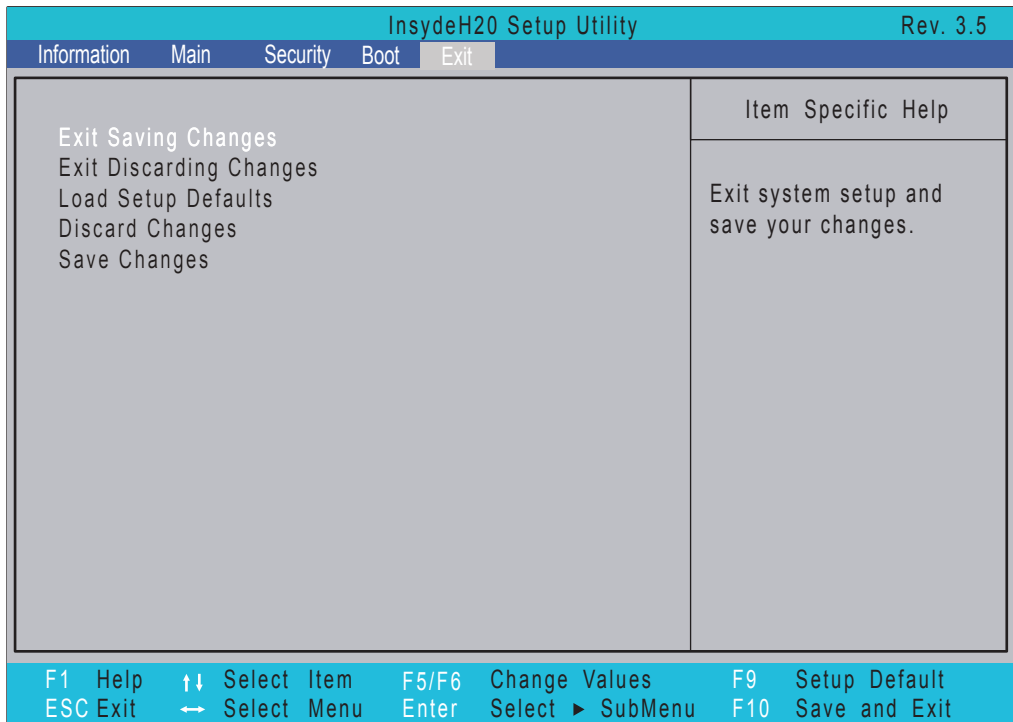

The table below describes the parameters in this screen.

Parameter	Description
Exit Saving Changes	Exit System Setup and save your changes.
Exit Discarding Changes	Exit utility without saving setup data.
Load Setup Default	Load default values for all SETUP item.
Discard Changes	Load previous values for all SETUP items.
Save Changes	Save Setup Data.

BIOS Flash Utilities

The BIOS Flash memory update is required for the following conditions:

- New versions of system programs
- New features or options
- Restore a BIOS when it becomes corrupted.

Use the Flash utility to update the system BIOS Flash ROM.

NOTE: If you do not have a crisis recovery diskette at hand, then you should create a **Crisis Recovery Diskette** before you use the Flash utility.

NOTE: Do not install memory-related drivers (XMS, EMS, DPMS) when you use the Flash.

NOTE: Please use the AC adaptor power supply when you run the Flash utility. If the battery pack does not contain enough power to finish BIOS Flash, you may not boot the system because the BIOS is not completely loaded.

Follow the steps below to run the Flash.

1. Prepare a bootable diskette.
2. Copy the Flash utilities to the bootable diskette.
3. Then boot the system from the bootable diskette. The Flash utility has auto-execution function.

DOS Flash Utility

Perform the following steps to use the DOS Flash Utility:

1. Press F2 during boot to enter the Setup Menu.
2. Select **Boot Menu** to modify the boot priority order, for example, if using USB HDD to Update BIOS, move USB HDD to position 1.

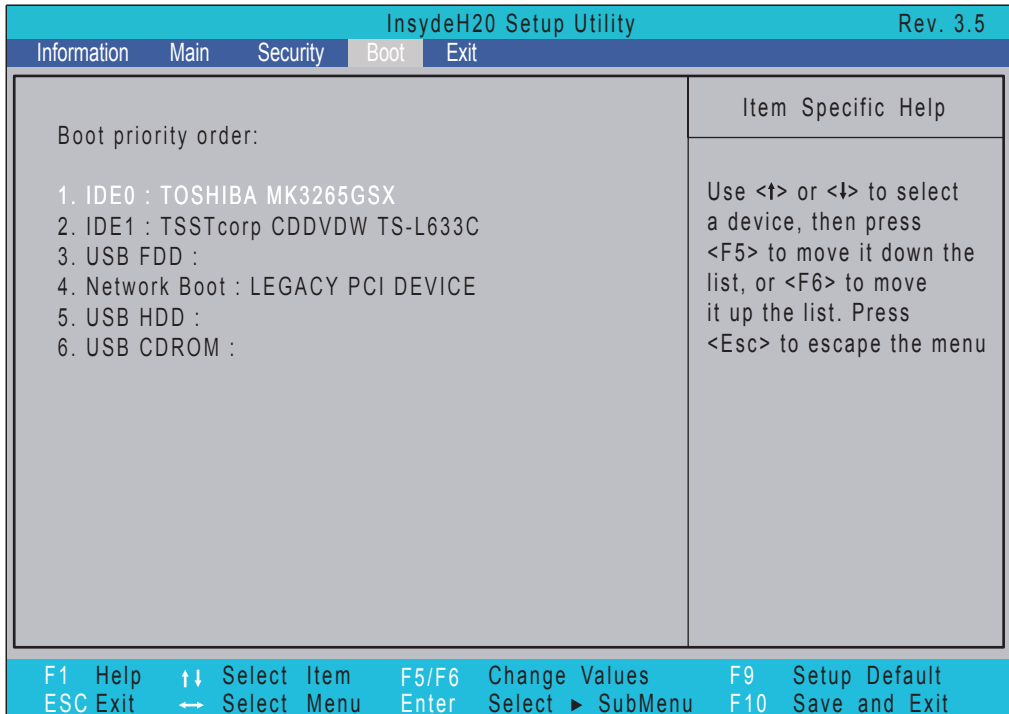

3. Execute the **BIOS.BAT** batch file to update BIOS.

The flash process begins as shown.

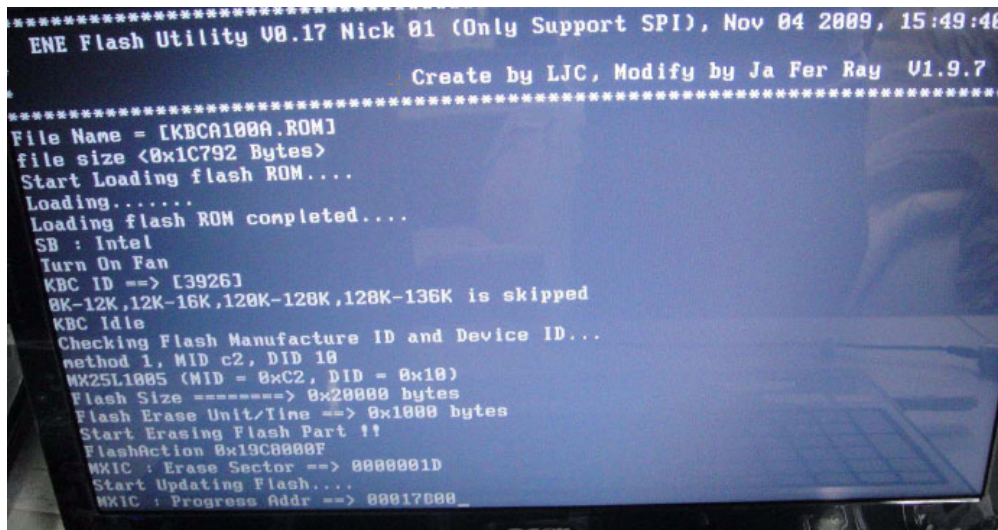

4. In flash BIOS, the message **Please do not remove AC Power Source** displays.

NOTE: If the AC power is not connected, the following message displays.

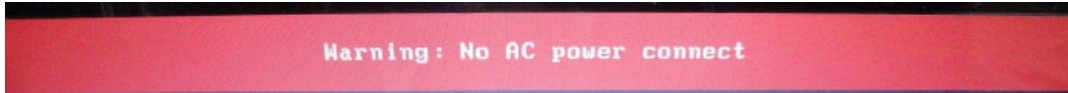

Plug in the AC power to continue.

5. Flash is complete when the message Flash programming complete displays.

WinFlash Utility

Perform the following steps to use the WinFlash Utility:

1. Double-click the WinFlash executable.
2. Click **OK** to begin the update. A progress screen displays.



Remove HDD/BIOS Password Utilities

This section provides you with details about removing HDD/BIOS password:

Remove HDD Password:

If you key in the wrong HDD password three times, an error is generated.



To reset the HDD password, perform the following steps:

1. After the error is displayed, select the **Enter Unlock Password** option on the screen.



2. An Encode key is generated for unlocking utilities. Note down this key.

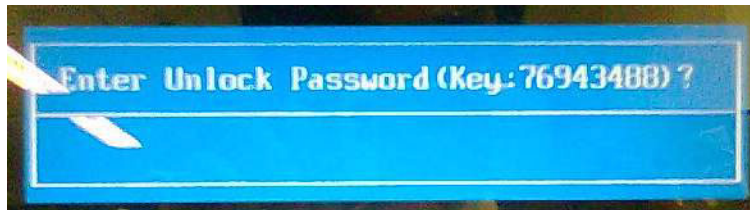

3. Execute the **UnlockHD.EXE** file to create the unlock code in DOS Mode using the format **UnlockHD [Encode code]** with the code noted in the previous step, as follows:

```
UnlockHD 76943488
```

4. The command generates a password which can be used for unlocking the HDD.

```
Password : 46548274
```

5. Key in the password from the previous step to unlock the HDD as shown.

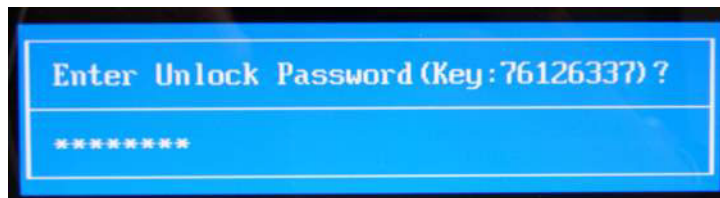

Removing BIOS Passwords

To clear the User or Supervisor passwords, open the DIMM door and use a metal instrument to short the **RTC_RST** point.

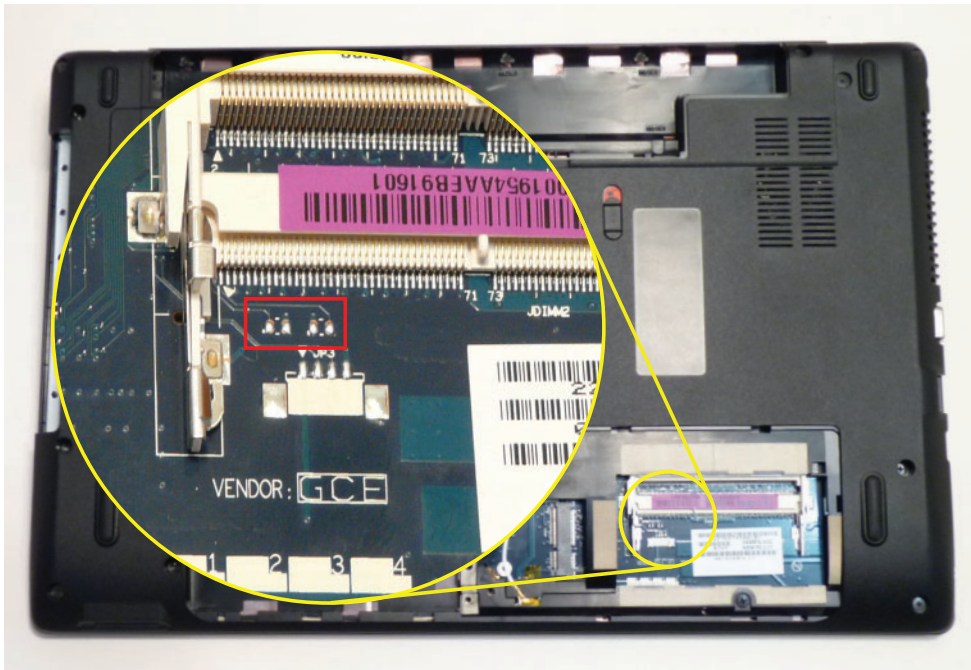

Cleaning BIOS Passwords

To clean the User or Supervisor passwords, perform the following steps:

1. From a DOS prompt, execute **clnPwd.exe**
2. Press **1** or **2** to clean the desired password shown on the screen.

```
d:\ClnPwd>clnPwd
ACER Clean Password Utility V1.00
Press 1 or 2 to clean any password shown as below
  1.User Password
  2.Supervisor Password

Clean User Password Successfully!
```

The onscreen message determines whether the function is successful or not.

Using Boot Sequence Selector

The Boot Sequence Selector allows the boot order to be changed without accessing the BIOS. To use Boot Sequence Selector, perform the following steps:

1. Enter into DOS.
2. Execute **BS.exe** to display the usage screen.

```
d:\BOOTSEQ>bs
*** Boot Sequence Selector Version 0.03 ***
Create by Rockwell Chuang 10/01/2005.
Usage:
      BS [ 1 | 2 | 3 | 4 ]
BS 1 : [ Floppy ] => [ HardDisk ] => [ CD-ROM ] => [ LAN ]
BS 2 : [ HardDisk ] => [ CD-ROM ] => [ LAN ] => [ Floppy ]
BS 3 : [ CD-ROM ] => [ HardDisk ] => [ LAN ] => [ Floppy ]
BS 4 : [ LAN ] => [ Floppy ] => [ HardDisk ] => [ CD-ROM ]
d:\BOOTSEQ>
```

3. Select the desired boot sequence by entering the corresponding sequence. For example, enter **BS2** to change the boot sequence to HDD | CD ROM | LAN | Floppy.

Using DMI Tools

The DMI (Desktop Management Interface) Tool copies BIOS information to EEPROM to be used in the DMI pool for hardware management.

When the BIOS displays **Verifying DMI pool data** it is checking that the table correlates with the hardware before sending to the operating system (Windows, etc.).

To update the DMI Pool, perform the following steps:

1. Boot into DOS.
2. Execute **dmitools**. The following messages report to screen to confirm completion:
 - `dmitools /r ==>` Read dmi string from bios
 - `dmitools /wm xxxx ==>` Write manufacturer name to eeprom (max. 16 characters)
 - `dmitools /wp xxxx ==>` Write product name to eeprom (max. 16 characters)
 - `dmitools /ws xxxx ==>` Write serial number to eeprom (max. 22 characters)
 - `dmitools /wu xxxx ==>` Write uuid to eeprom
 - `dmitools /wa xxxx ==>` Write asset tag to eeprom (max. 32 characters)

The following examples show the commands and the corresponding output information.

Read DMI Information from Memory

Input:

```
dmitools /r
```

Output:

```
Manufacturer (Type1, Offset04h): Acer
```

```
Product Name (Type1, Offset05h): TravelMate xxxxx
```

```
Serial Number (Type1, Offset07h): 01234567890123456789
```

```
UUID String (Type1, Offset08h): xxxxxxxx-xxxx-xxxx-xxxx-xxxxxxxxxxxx
```

```
Asset Tag (Type3, Offset04h): Acet Asstag
```

Write Product Name to EEPROM

Input:

```
dmitools /wp Acer
```

Write Serial Number to EEPROM

Input:

```
dmitools /ws 01234567890123456789
```

4). Write UUID to EEPROM (Create UUID from Intel WFM20.pdf)

Input:

```
dmitools /wu
```

5). Write Asset Tag to EEPROM

Input:

```
dmitools /wa Acet Asstag
```

NOTE: When using any of the Write options, restart the system to make the new DMI data effective.

Using the LAN MAC EEPROM Utility

You can use the MAC.BAT utility to write the MAC.CFG file to the EEPROM under DOS mode.

1. Use a text editor (for example: Notepad) to open the MAC.CFG file. You can see the MAC.CFG contents as below:



```
MAC.CFG - 記事本
檔案(F) 編輯(E) 格式(O) 檢視(V) 說明(H)
Title= MAC Address byte
WriteData='001122334455'
StartAddr=7A
WriteLeng=6
KeepByte=0
```

WriteData = '001122334455'	MAC value
StartAddr=7A	MAC address
WriteLeng=6	MAC value length
KeepByte=0	don't care

2. In DOS mode, run the **MAC.BAT** file to write MAC values to eeprom.

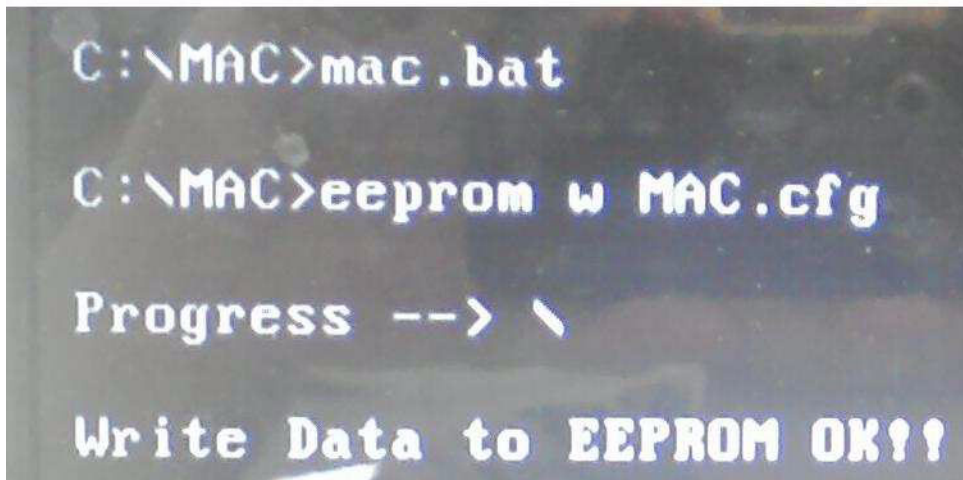

```
C:\MAC>mac.bat
C:\MAC>eeprom w MAC.cfg
Progress --> \
Write Data to EEPROM OK!!
```

Machine Disassembly and Replacement

IMPORTANT: The outside housing and color may vary from the mass produced model.

This chapter contains step-by-step procedures on how to disassemble the notebook computer for maintenance and troubleshooting.

Disassembly Requirements

To disassemble the computer, you need the following tools:

- Wrist grounding strap and conductive mat for preventing electrostatic discharge
- Flat screwdriver
- Philips screwdriver
- Plastic flat screwdriver
- Plastic tweezers

NOTE: The screws for the different components vary in size. During the disassembly process, group the screws with the corresponding components to avoid mismatch when putting back the components.

Pre-disassembly Instructions

Before proceeding with the disassembly procedure, make sure that you do the following:

1. Turn off the power to the system and all peripherals.
2. Unplug the AC adapter and all power and signal cables from the system.



3. Place the system on a flat, stable surface.
4. Remove the battery pack.

Disassembly Process

IMPORTANT: The LCD Module cannot be disassembled outside of factory conditions. If any part of the LCD Module is faulty, such as the camera, antenna or LCD panel, the whole module must be replaced.

The disassembly process is divided into the following stages:

- External module disassembly
- Main unit disassembly
- LCD module disassembly

The flowcharts provided in the succeeding disassembly sections illustrate the entire disassembly sequence. Observe the order of the sequence to avoid damage to any of the hardware components. For example, if you want to remove the mainboard, you must first remove the keyboard, then disassemble the inside assembly frame in that order.

Main Screw List

Screw	Quantity	Part Number
SCREW 2.5D 5L K 5.5D ZK NL CR3	9	86.WJ802.001
SCREW 2.45D 8.0L K 5.5D 0.8T ZK NL	19	86.WJ802.002
SCREW 2.5D 6L K 5.5D NI NL	4	86.WJ802.003
SCREW 1.98D 3.0L K 4.6D 0.8T ZK NL	24	86.WJ802.004
SCREW 3.0D 3.0L K 4.9D NI	4	86.WJ802.005
SCREW ASSY CPU THERMAL	4	86.WJ802.006

External Module Disassembly Process

IMPORTANT: The outside housing and color may vary from the mass produced model.

External Modules Disassembly Flowchart

The flowchart below gives you a graphic representation of the external module disassembly sequence and instructs you on the components that need to be removed during servicing. For example, if you want to remove the keyboard, you must first remove the switch board.

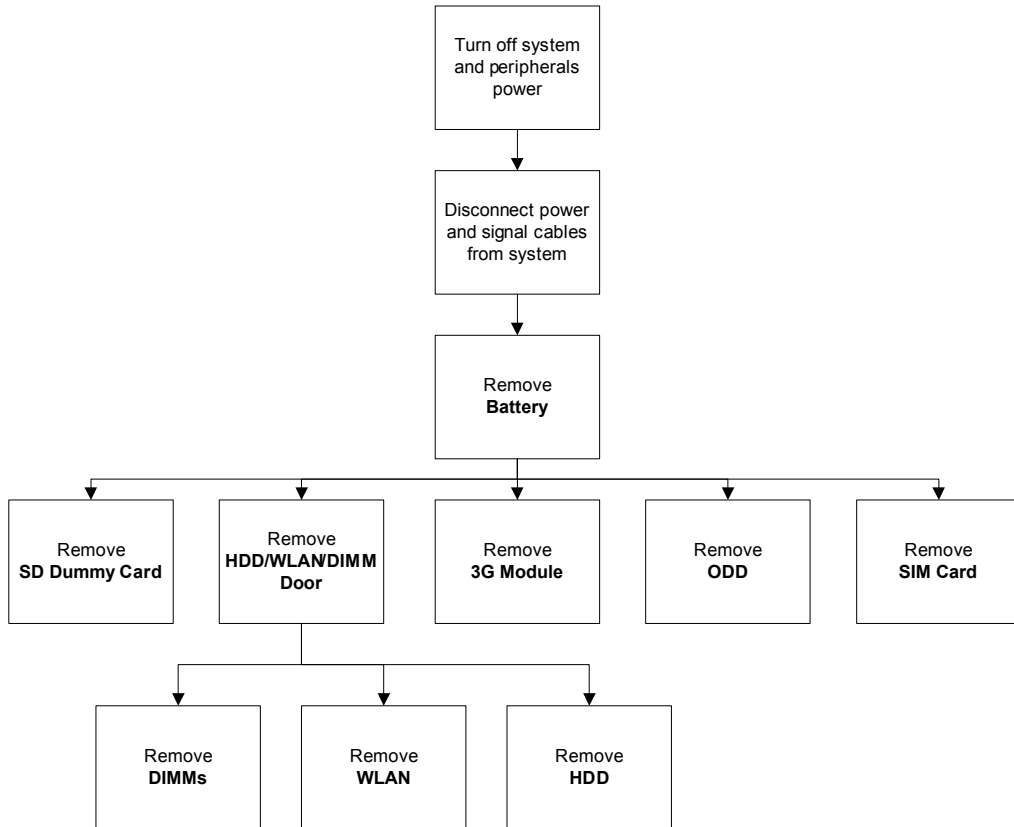

Screw List

Step	Screw	Quantity	Part No.
ODD Module	M2.5*8	1	86.WJ802.002
ODD Bracket	M2*3	2	86.WJ802.004
Logic Lower door	M2.5*8	2	86.WJ802.002
3G Module	M2.5*8	1	86.WJ802.002
WLAN Module	M2*3	1	86.WJ802.004
HDD Carrier	M3*3	4	86.WJ802.005

Removing the Battery Pack

1. Turn computer over. Slide the battery lock in the direction shown.

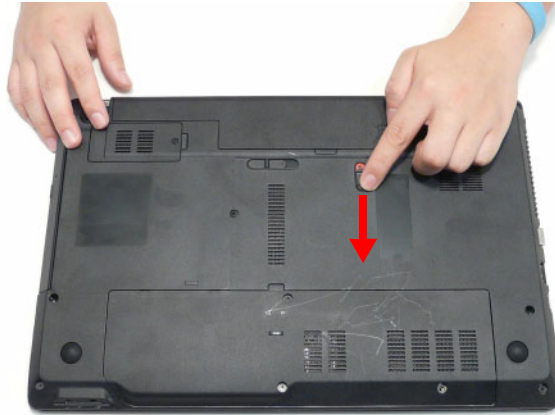

2. Slide and hold the battery release latch to the release position (1), then lift out the battery pack from the main unit (2).



NOTE: The battery has been highlighted with a yellow oval as shown in the above image. Please detach the battery and follow local regulations for disposal.

Removing the SIM Card

1. See "Removing the Battery Pack" on page 45.
2. Push the SIM card all the way in to eject it.

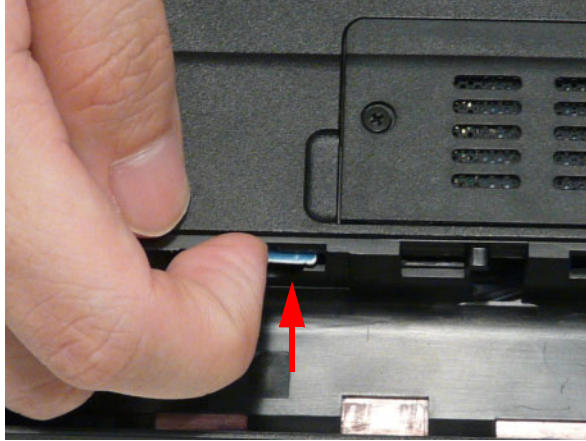

3. Pull it out from the slot.

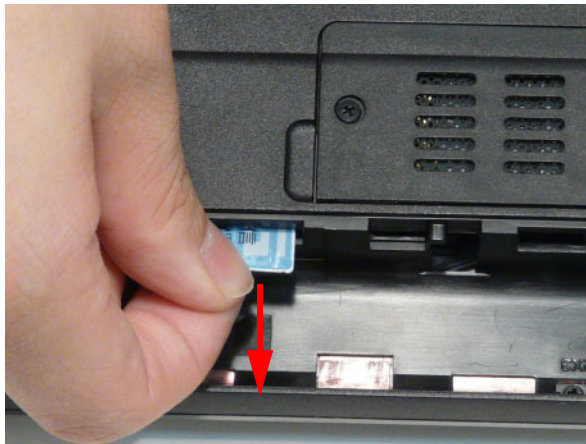

Removing the SD Dummy Card

1. Push the SD dummy card all the way in to eject it.



2. Pull it out from the slot.



Removing the Optical Drive Module

1. See "Removing the Battery Pack" on page 45.
2. Remove the screw securing the ODD module.



Step	Size	Quantity	Screw Type
ODD Module	M2.5*8	1	

3. Pull the optical drive module out from the chassis.

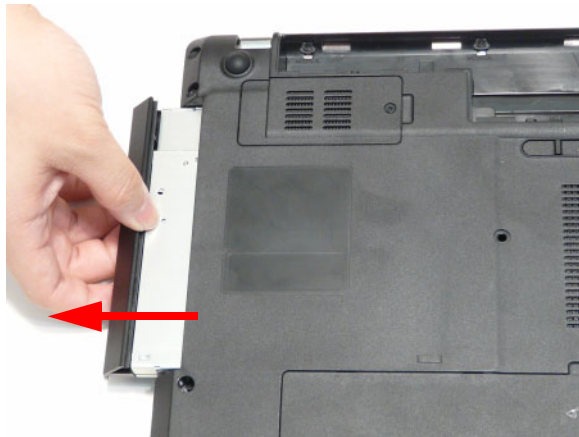

4. Remove the two (2) screws securing the ODD bracket and remove the ODD bracket from the optical disk drive module.



Step	Size	Quantity	Screw Type
ODD Bracket	M2*3	2	

5. Remove the ODD bezel by prying the top edge away and clear of the module.



Removing the Logic Lower Door

1. Remove three (3) screws from the Logic Lower Door.

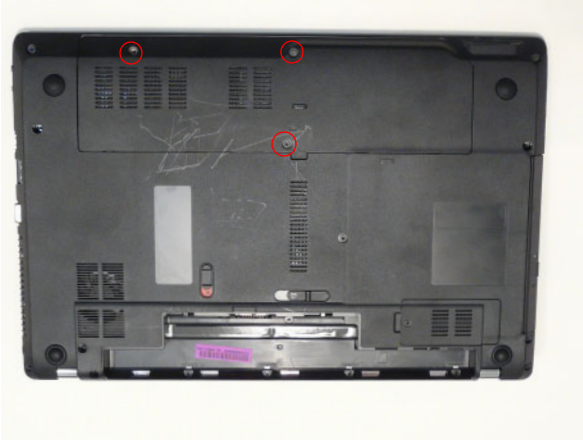

Step	Size	Quantity	Screw Type
Logic Lower door	M2.5*8	2	

2. Lift the door beginning from the inner edge as shown.



3. Lift the door clear off the device, exposing the HDD, DIMM, and WLAN modules.

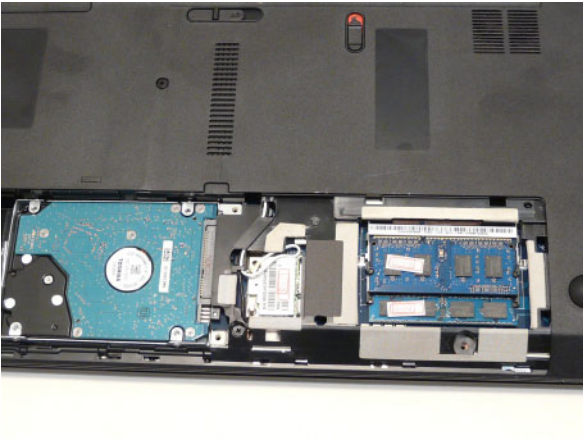

Removing the 3G Module

1. Loosen one (1) screw on the 3G Cover.



Step	Size	Quantity	Screw Type
3G Cover	M2.5*8	1	

2. Lift the 3G Cover from the left edge first, then remove completely.



3. Remove the two (2) antenna cables from the 3G module.



4. Remove one (1) screw from the 3G module.



5. Lift the 3G card from the slot.



Removing the DIMM Module

1. See “Removing the Logic Lower Door” on page 50.
2. Push out the release latches on both sides of the DIMM socket to release the DIMM module.

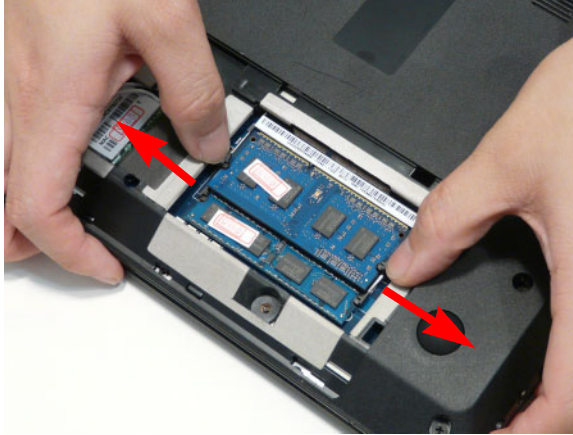

3. Remove the DIMM module.



4. Repeat steps 2 and 3 for the second DIMM module if present.

Removing the WLAN Module

1. See "Removing the Logic Lower Door" on page 50.
2. Disconnect the two (2) antenna cables from the WLAN Board.

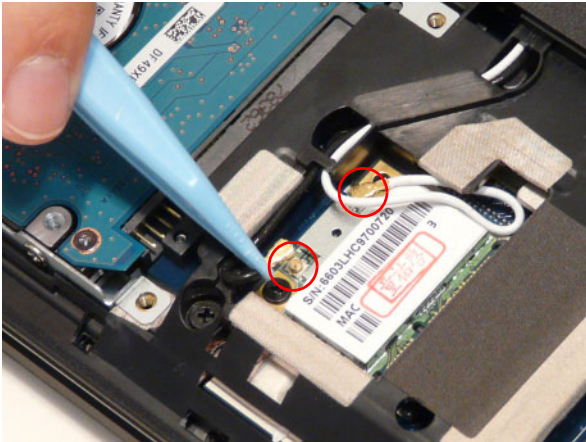

3. Move the antenna away and remove the one (1) screw to release the WLAN Board.

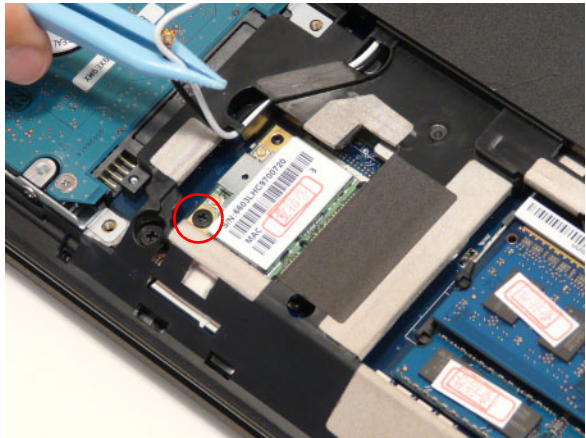

Step	Size	Quantity	Screw Type
WLAN Module	M2*3	1	

-
4. Detach the WLAN Board from the WLAN socket.

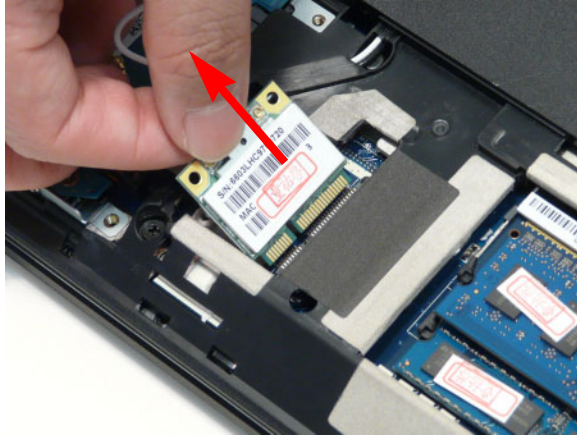

NOTE: When reattaching the antennas, ensure the cables are tucked into the chassis to prevent damage.

Removing the Hard Disk Drive Module

1. See “Removing the Logic Lower Door” on page 50.
2. Using the pull-tab, slide the HDD Module in the direction of the arrow to disconnect the interface.

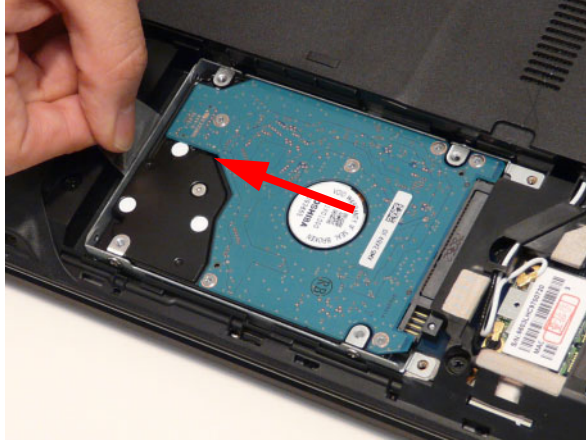



3. Lift the HDD Module clear of the HDD bay.

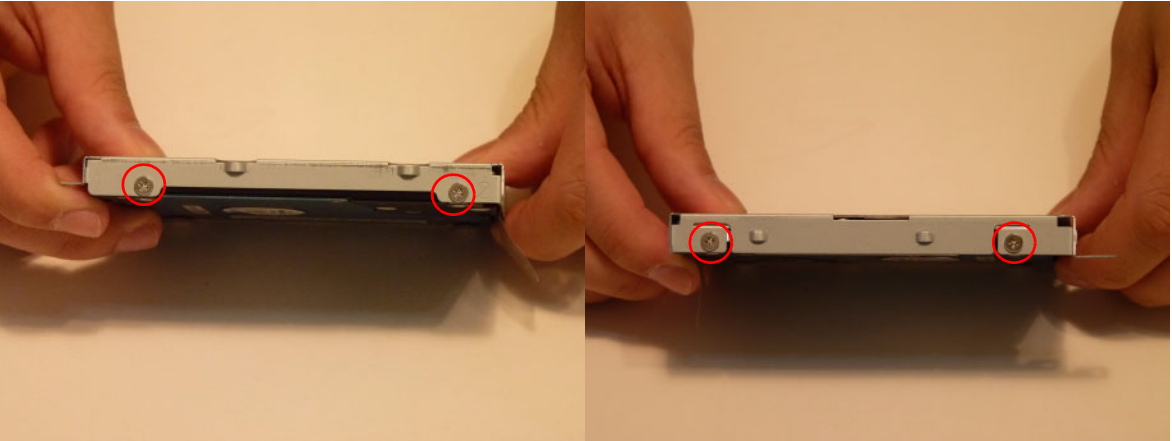

NOTE: To prevent damage to device, avoid pressing down on it or placing heavy objects on top of it.

4. Remove the four (4) screws (two each side) securing the hard disk to the carrier.



Step	Size	Quantity	Screw Type
HDD Carrier	M3*3	4	

5. Remove the HDD from the carrier.

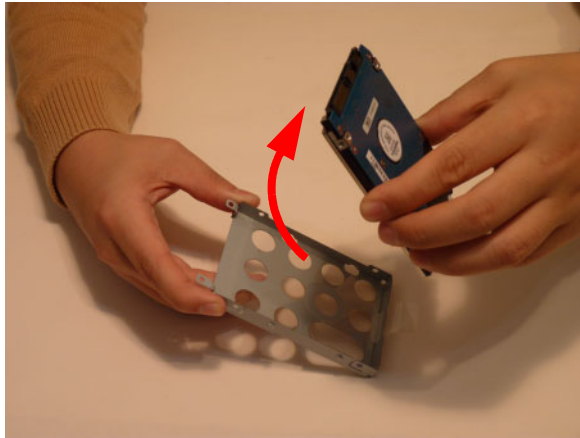

Main Unit Disassembly Process

Main Unit Disassembly Flowchart

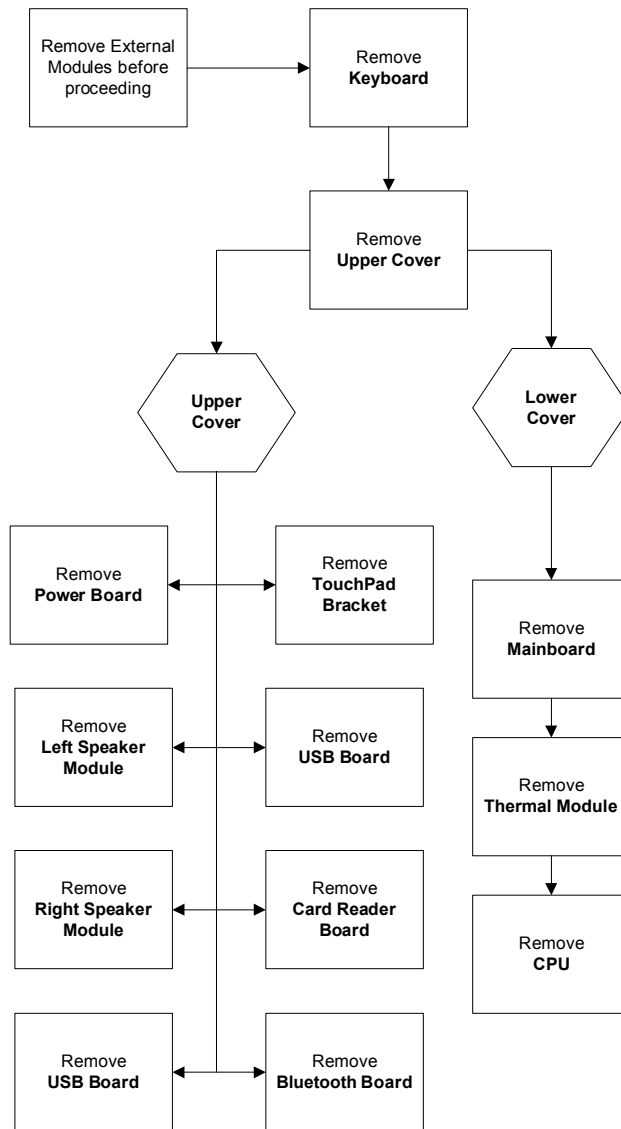

Screw List

Step	Screw	Quantity	Part No.
Lower Cover	M2.5*8	11	86.WJ802.002
Lower Cover	M2*3	5	86.WJ802.004
Upper Cover	M2.5*5	7	86.WJ802.001
Power Board	M2*3	2	86.WJ802.004
Left Speaker Module	M2*3	2	86.WJ802.004
Right Speaker Module	M2*3	2	86.WJ802.004
Card Reader	M2*3	1	86.WJ802.004
USB Board	M2*3	1	86.WJ802.004

Step	Screw	Quantity	Part No.
TouchPad Bracket	M2*3	2	86.WJ802.004
Mainboard	M2.5*5	1	86.WJ802.001
Thermal Module	M1.98*3.0	4	86.WJ802.004

Removing the Keyboard

1. Unlock the six (6) keyboard locks.

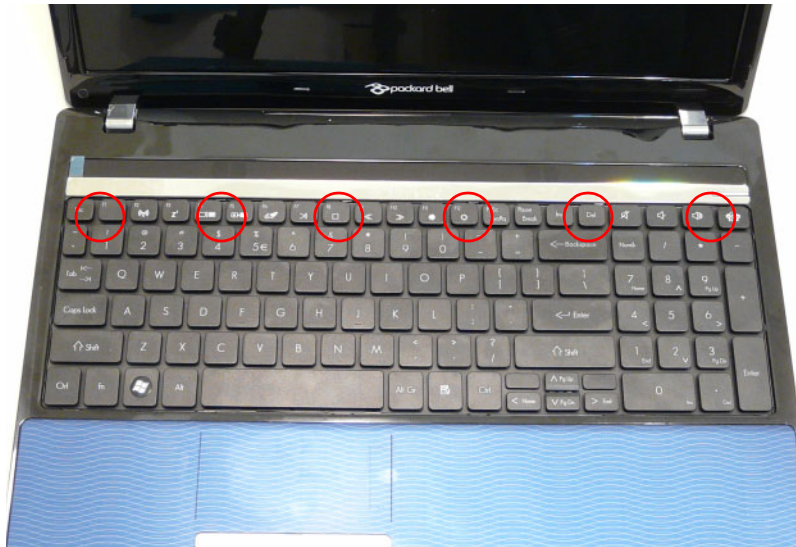

2. Pry up the centre of the Keyboard and rotate it upward away from the Upper Cover.



3. Turn the keyboard over on to the TouchPad area to expose the FPC connector.



4. Open the locking latch and disconnect the FPC from the mainboard.

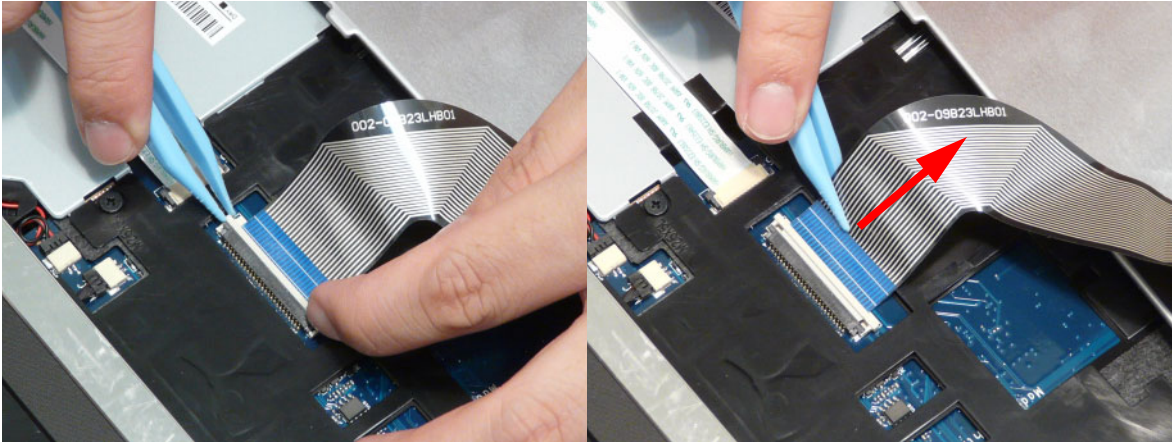



5. Lift the keyboard clear of the Upper Cover.

Removing the Upper Cover

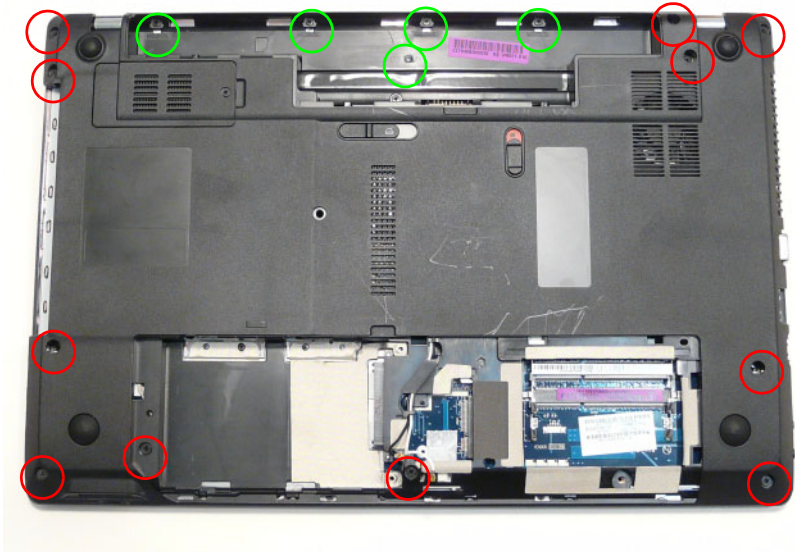
1. See "External Module Disassembly Process" on page 44.
2. Turn the computer over. Remove the eleven (11) screws on the lower cover and five (5) screws from the battery bay.



Step	Size	Quantity	Screw Type
Upper Cover (red callout)	M2.5*8	11	
Battery Bay (green callout)	M2*3	5	

3. Disconnect the following four (4) cables from the Mainboard.

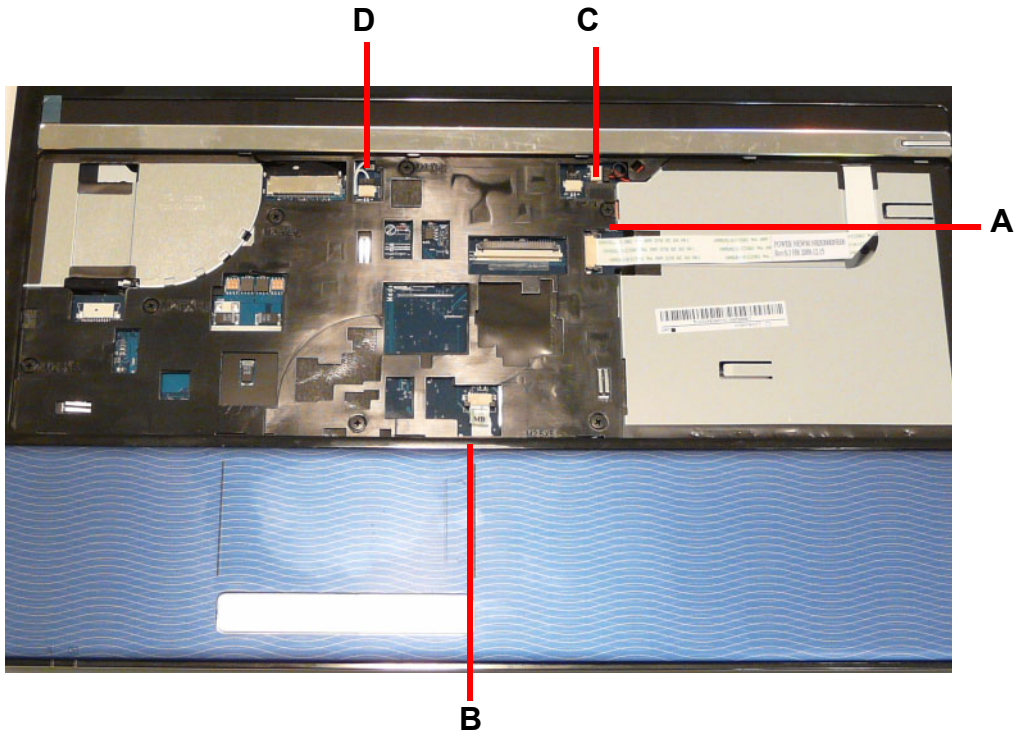

4. Release the locking latch on **A** and disconnect the cable.

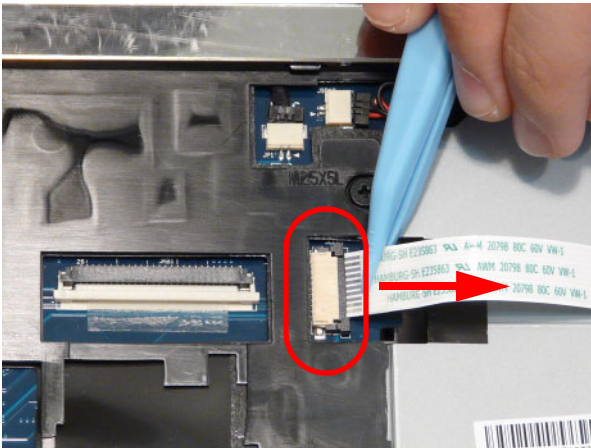

5. Pull the cable off the adhesive as shown.



6. Release the locking latch on **B** and remove the cable as shown.

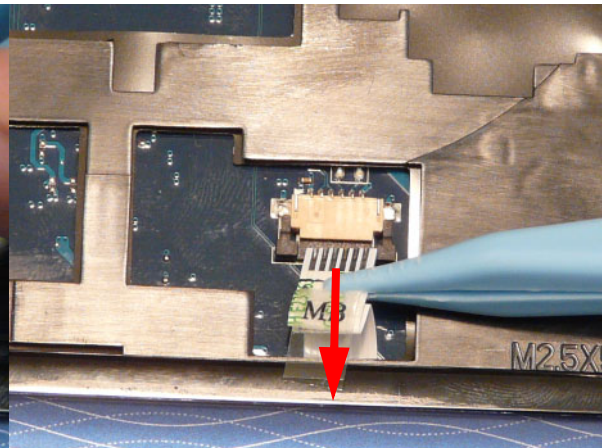
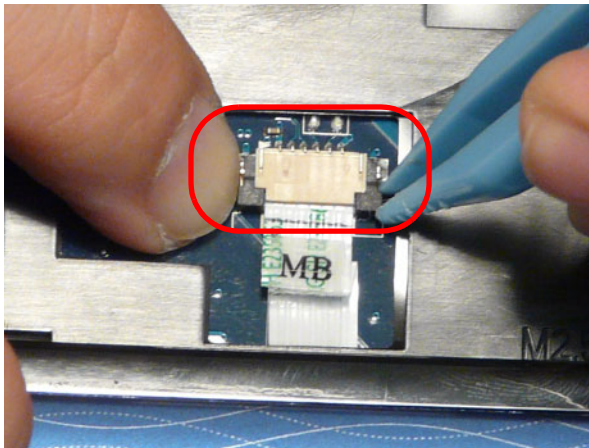

7. Release the locking latch on **C** and remove the cable as shown.

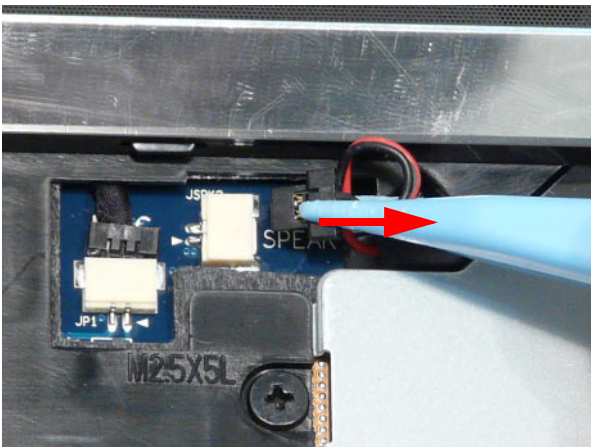

8. Release the locking latch on **D** and remove the cable as shown.

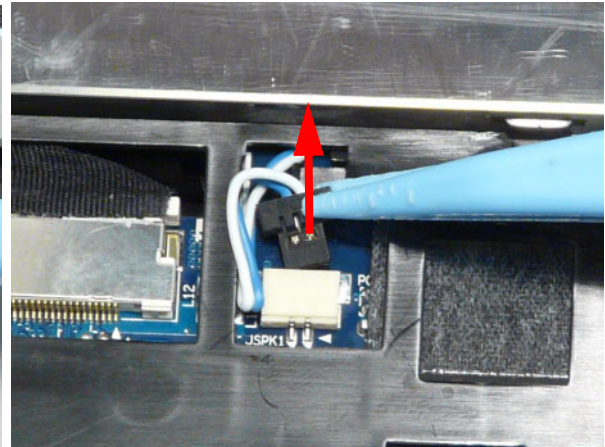

NOTE: Avoid pulling on cables directly to prevent damage to the connectors.

NOTE: Use the pull-tabs on FFCs whenever available to prevent damage.

9. Remove the seven (7) screws on the Upper Cover as shown.

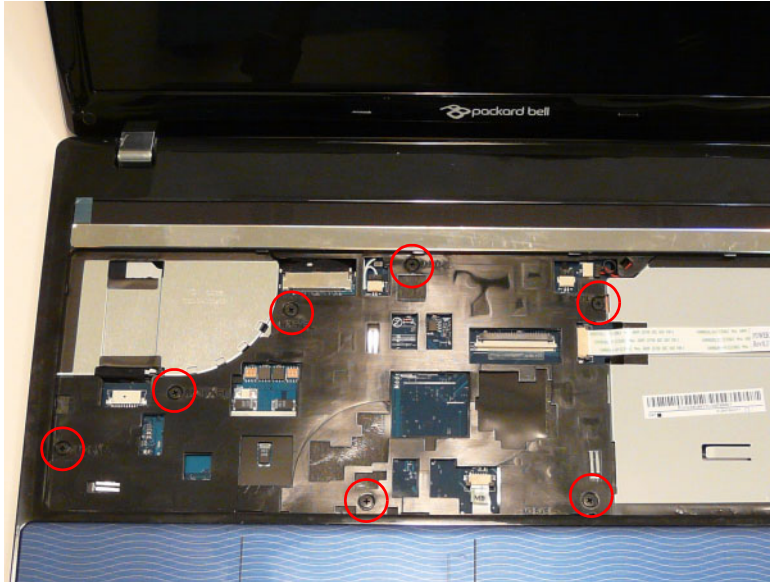

Step	Size	Quantity	Screw Type
Upper Cover	M2.5*5	7	

10. Starting at the top right side of the cover, pry apart the Upper and Lower Covers as shown. Work along the front edge of the casing to the left as shown, then lift the Upper Cover clear of the Lower Cover.

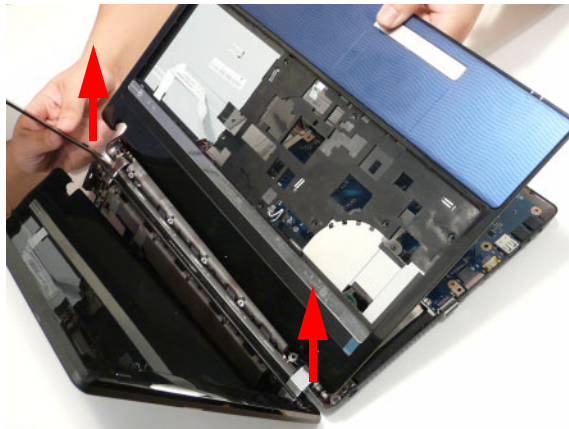
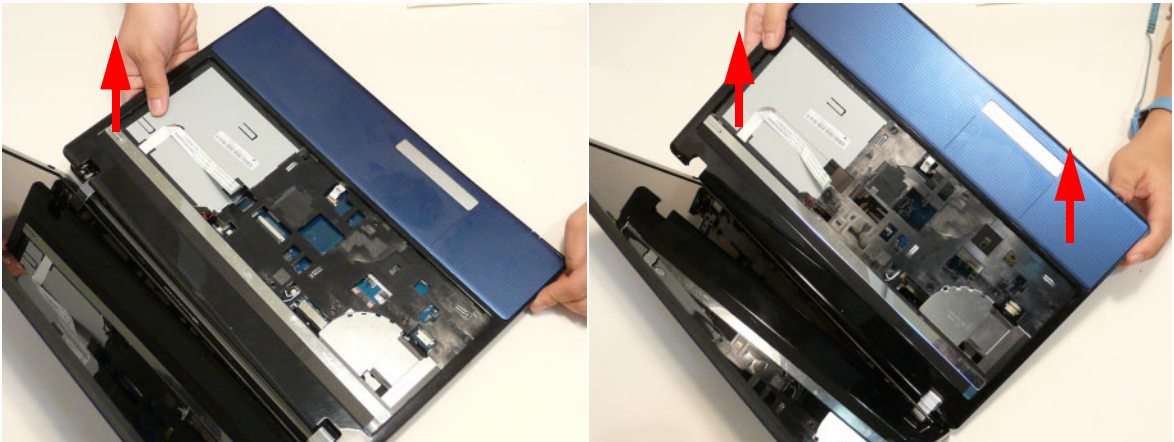

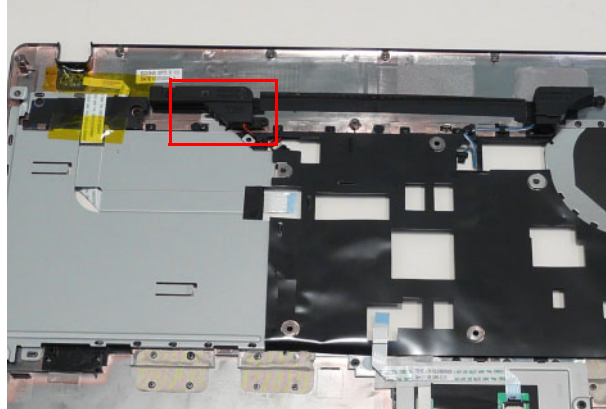

Removing the Left Speaker Module

1. See "Removing the Upper Cover" on page 62.
2. Locate the Left Speaker Module on the Upper Cover as shown.

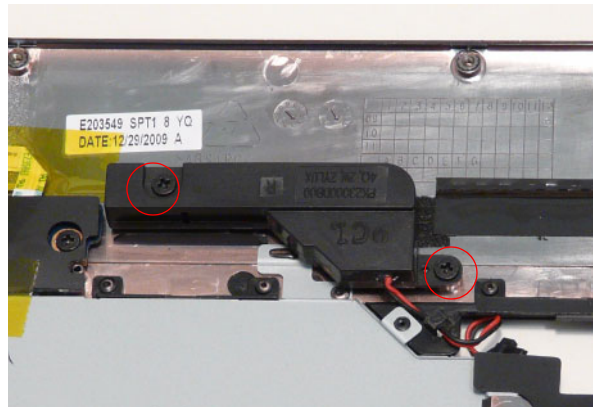

3. Remove two (2) screws from the left speaker module.



Step	Size	Quantity	Screw Type
Left Speaker Module	M2*3	2	

4. Lift the Speaker clear of the Upper Cover. Ensure that the cable is free from all cable clips.

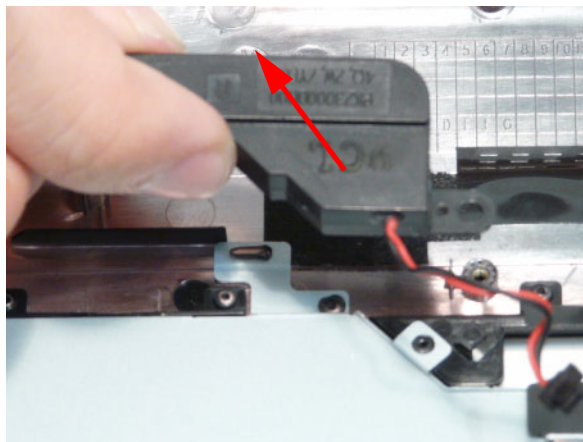

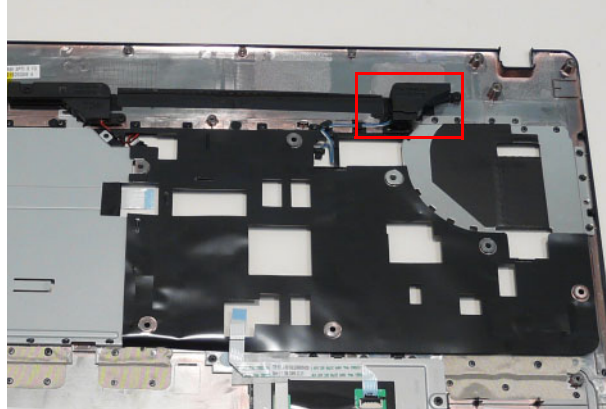

Removing the Right Speaker Module

1. See "Removing the Upper Cover" on page 62.
2. Locate the Right Speaker Module on the Upper Cover as shown.

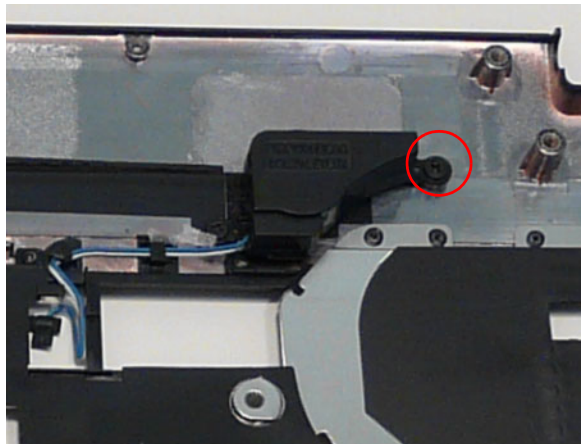

3. Remove the one (1) securing screw from the Right Speaker Module.



Step	Size	Quantity	Screw Type
Right Speaker Module	M2*3	1	

4. Remove the Right Speaker Module cable from the cable channel. Ensure that the cable is free from all cable clips.

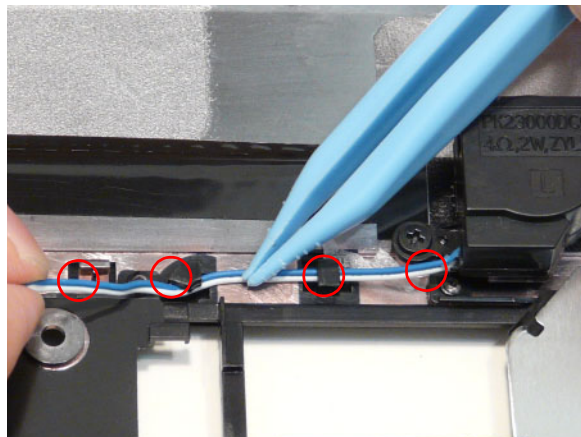

5. Lift the Right Speaker Module clear of the upper cover.

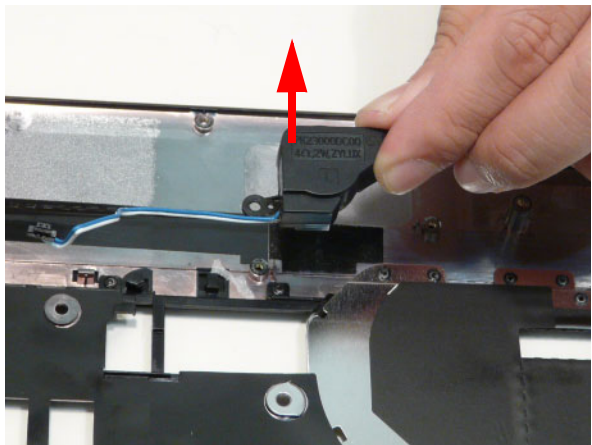

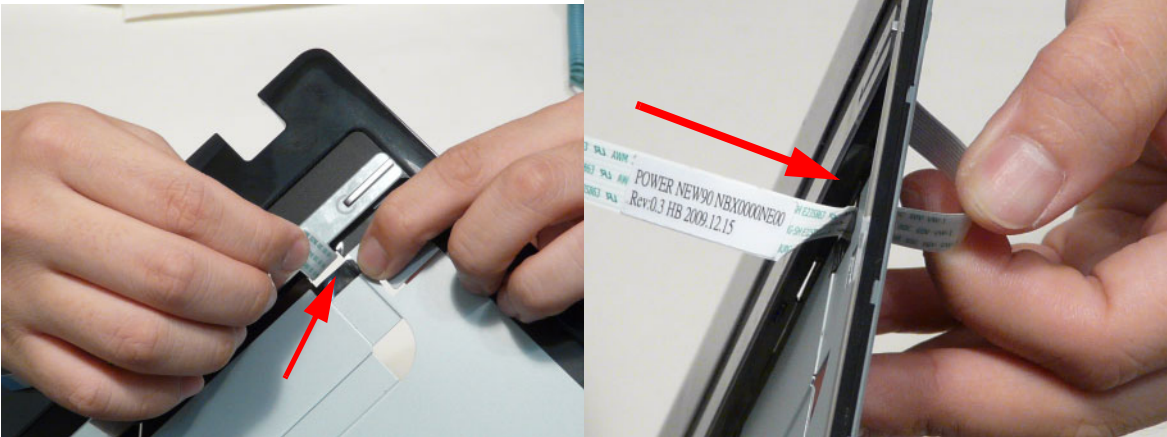

Removing the Power Board

1. See "Removing the Upper Cover" on page 62.
2. Turn the upper cover over. Pass the cable through the upper cover as shown.

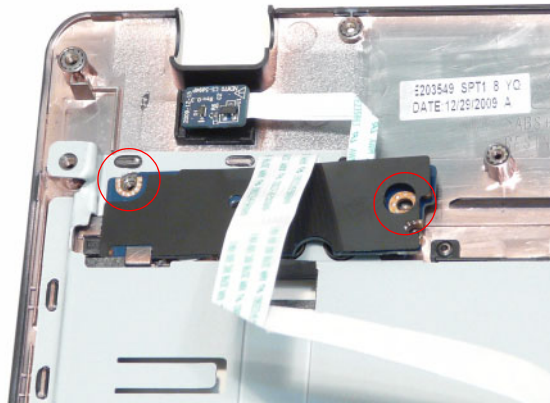

3. Remove two (2) screws from the power board.



Step	Size	Quantity	Screw Type
Power board	M2*3	2	

4. Remove the power board assembly and lift the power board clear of the device.

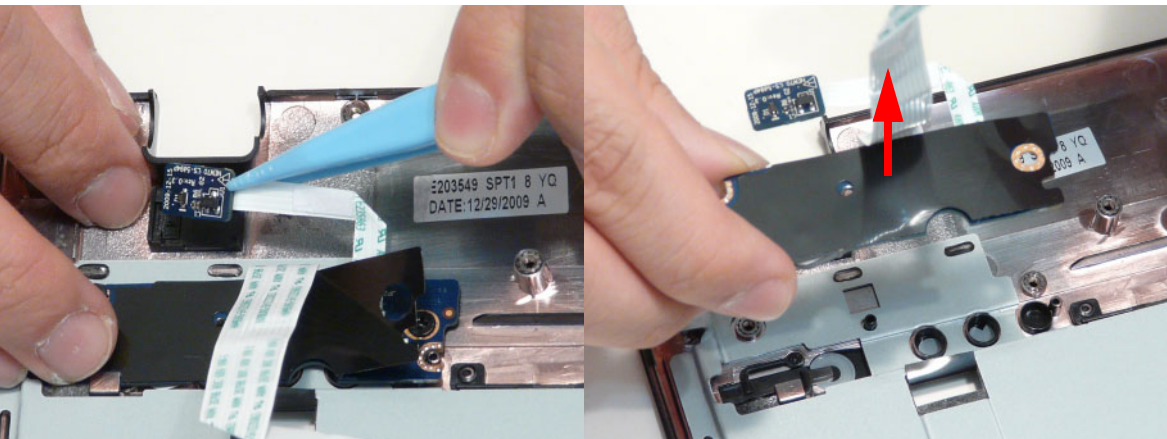

Removing the TouchPad Bracket

IMPORTANT: The TouchPad Board cannot be removed individually. To replace the TouchPad Board, replace the entire Upper Cover.

1. See “Removing the Upper Cover” on page 62.
2. Lift the FFC to detach the adhesive securing the cable to the Upper Cover.

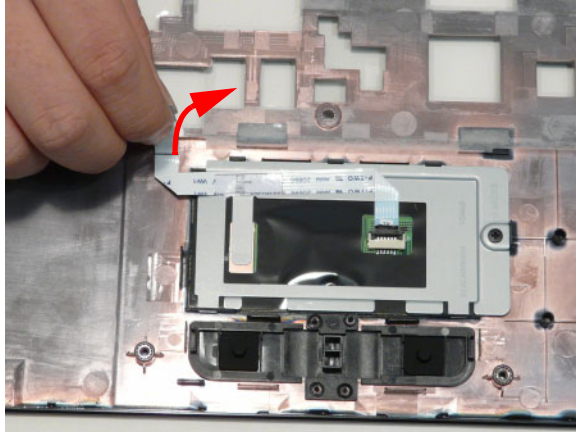

3. Release the FFC locking latch and disconnect the TouchPad FFC from the cover.

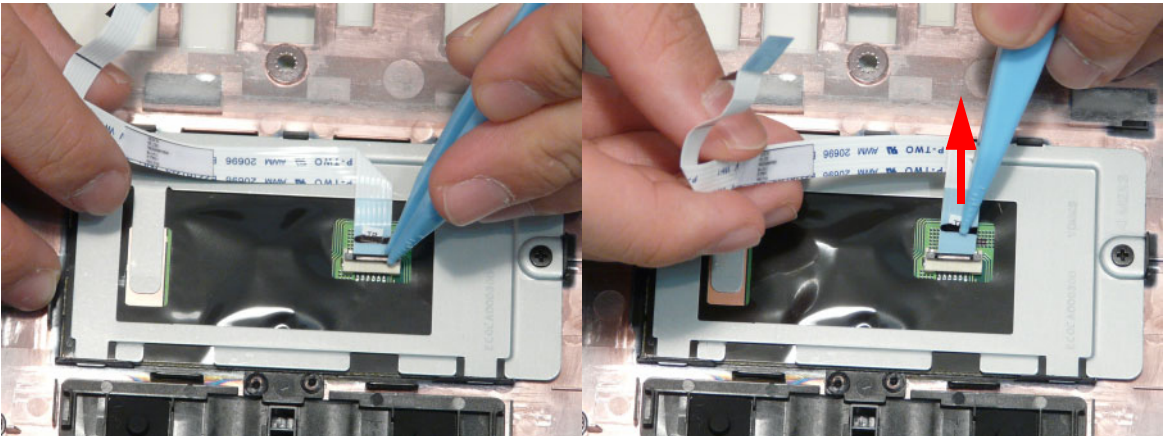

4. Remove the one (1) screw from TouchPad bracket.

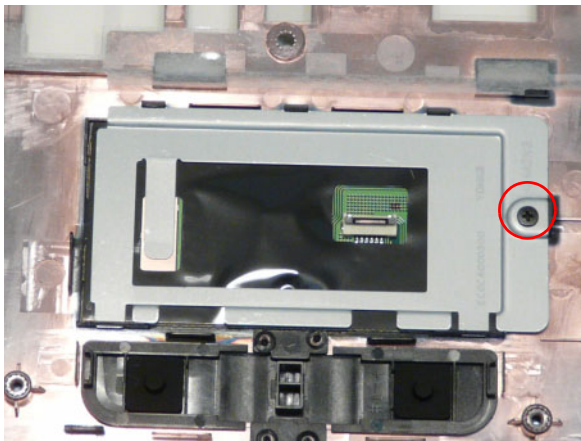

Step	Size	Quantity	Screw Type
TouchPad Bracket	M2*3	1	

5. Pry the Touchpad bracket off the adhesive and remove it as shown.

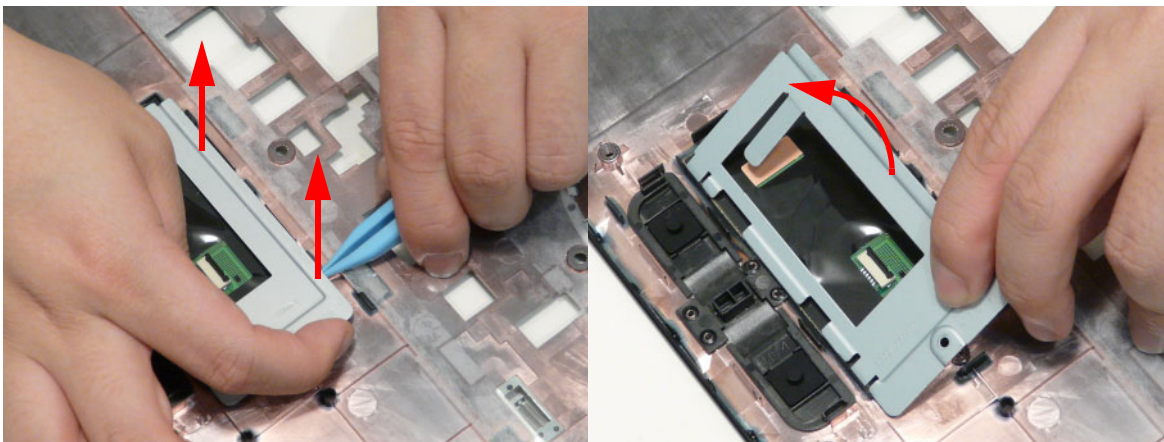

Removing the Card Reader Board

1. See “Removing the Upper Cover” on page 62.
2. Unlock the mainboard to card reader cable connector.

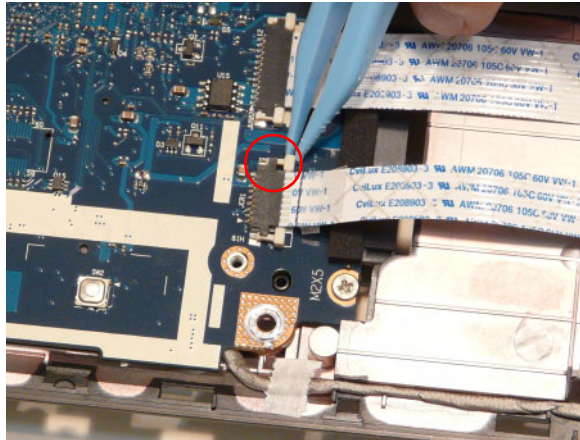

3. Remove the cable from the chassis by pulling up on the adhesive.

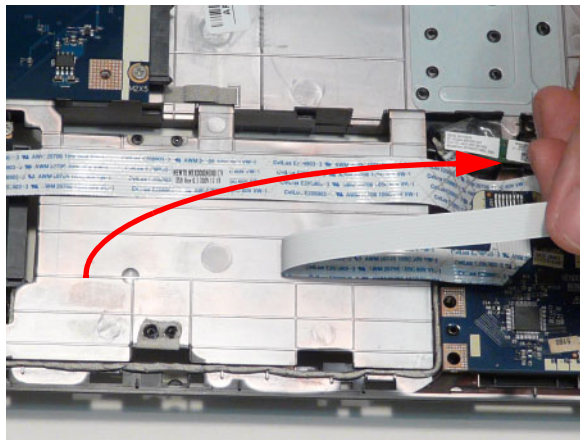

4. Remove one (1) screw from the card reader board.

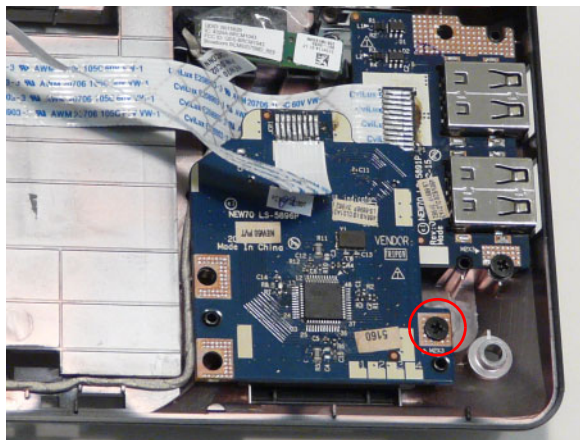

Step	Size	Quantity	Screw Type
Card Reader	M2*3	1	

5. Lift the card reader board clear of the device.

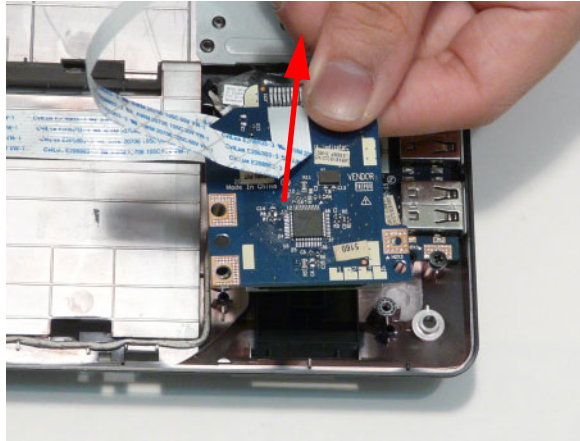

Removing the USB Board

1. See "Removing the Upper Cover" on page 62.
2. Unlock the mainboard to USB cable connector.

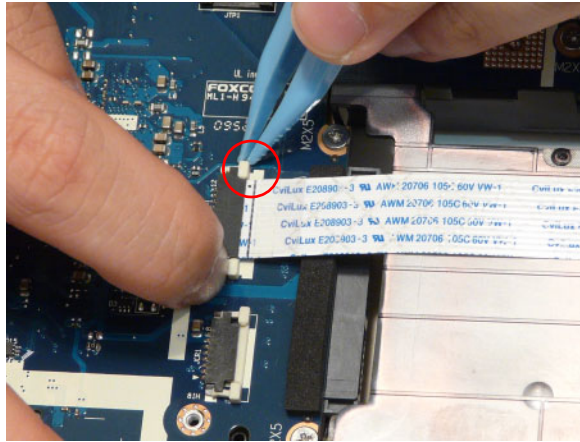

3. Remove the cable from the chassis by pulling up on the adhesive.

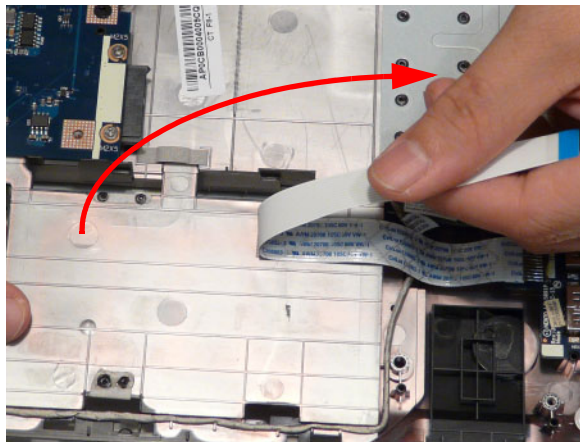

4. Remove one (1) screw from the USB board.

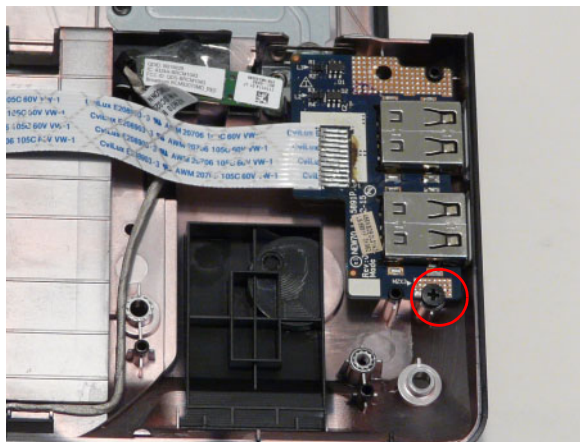

Step	Size	Quantity	Screw Type
USB	M2*3	1	

5. Lift the USB board clear of the device.

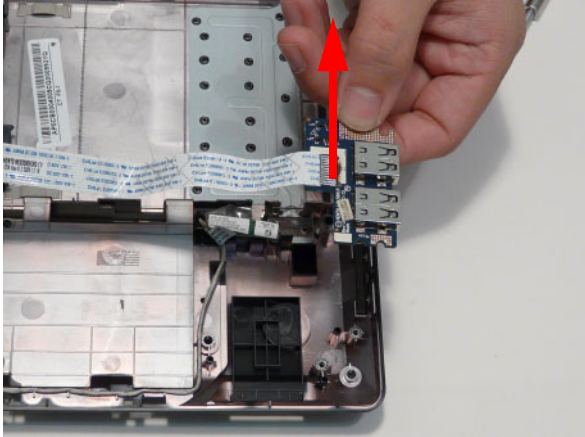

Removing the Bluetooth Board

1. See “Removing the Upper Cover” on page 62.
2. Pry the Bluetooth board from the adhesive.

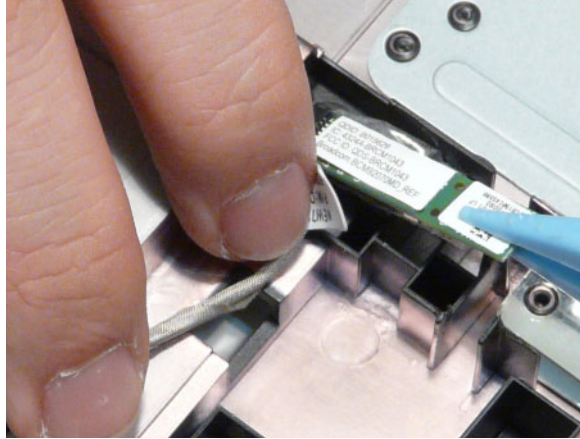

3. Disconnect the mainboard to Bluetooth cable.

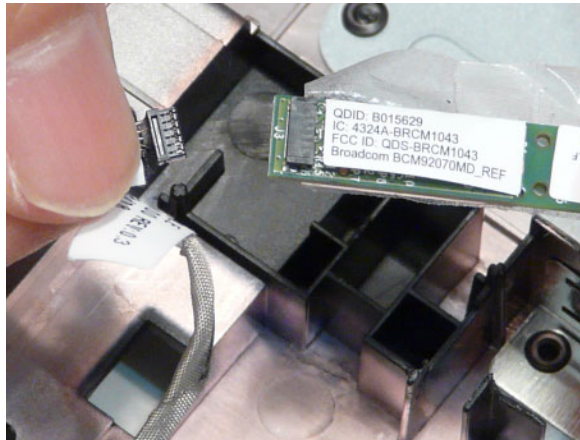

4. Lift the Bluetooth board away from the cable channel as shown.

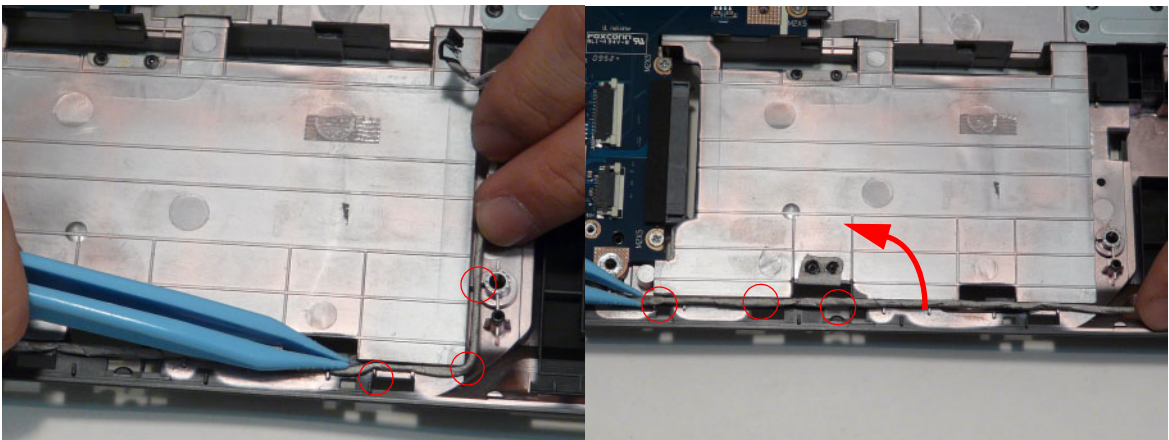

Removing the Mainboard

1. See "Removing the Upper Cover" on page 62.
2. Unlock the microphone cable connector and disconnect the cable.

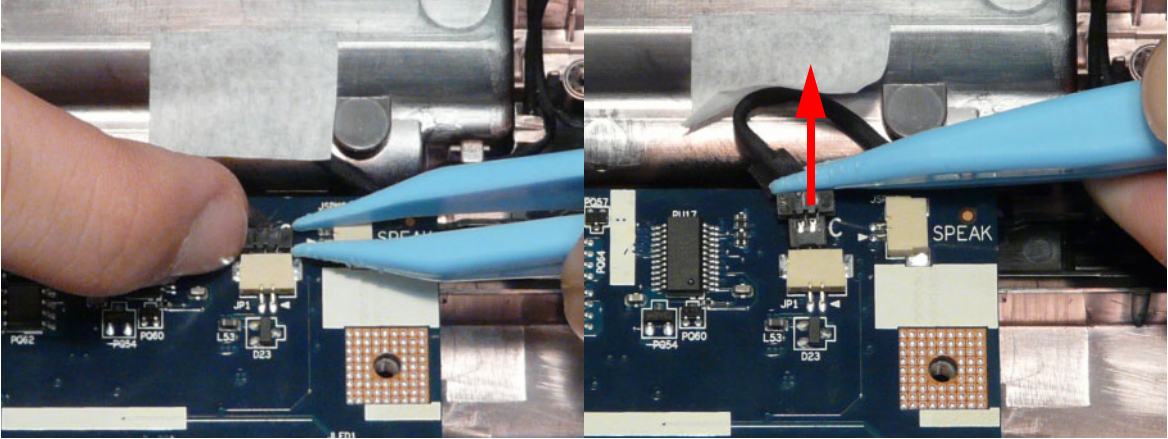

3. Disconnect the LVDS cable.

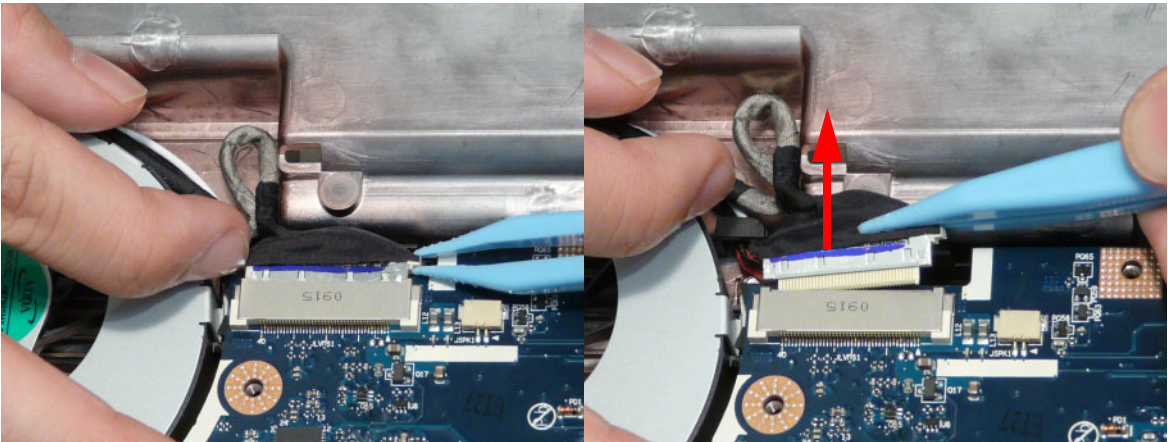

4. Remove the one (1) securing screw from the Mainboard.

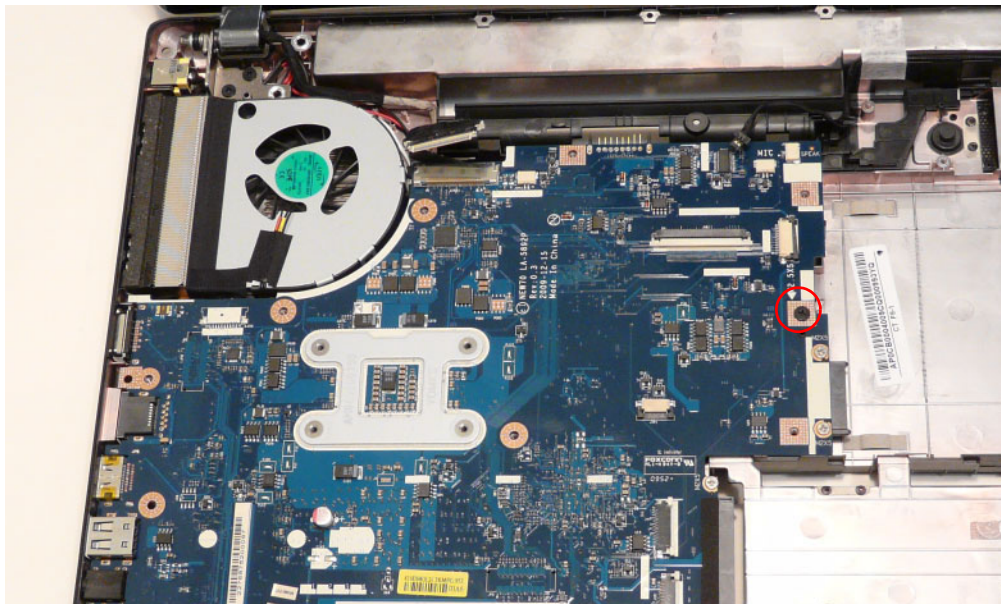

Step	Size	Quantity	Screw Type
Mainboard	M2.5*5	1	

5. Without removing completely, lift the mainboard from the chassis from the right edge first.

CAUTION: Do not remove the mainboard completely. The mainboard is still connected to the chassis.

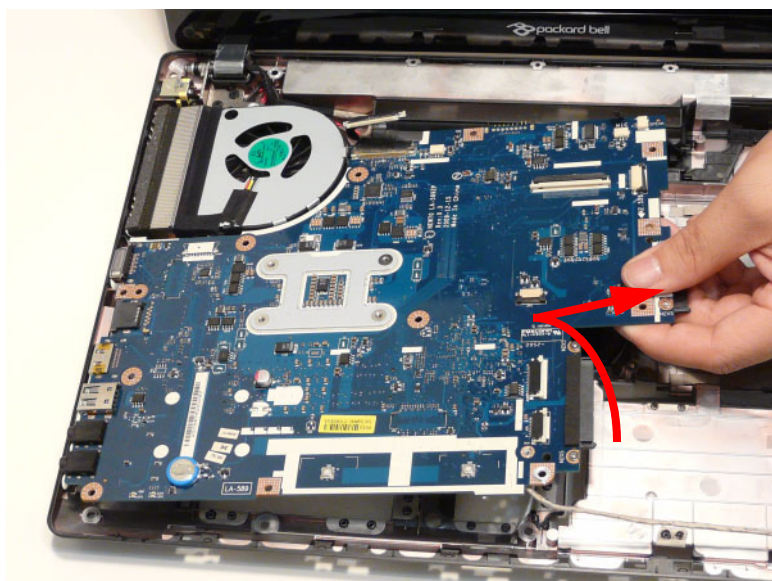

6. Carefully turn the mainboard over and place it on a clean, dust-free surface.

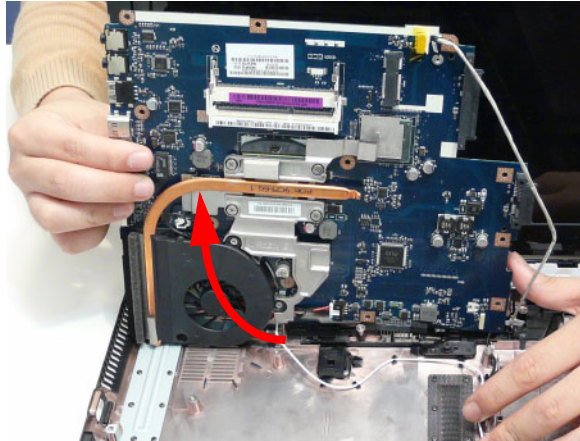

7. Disconnect the power cable.

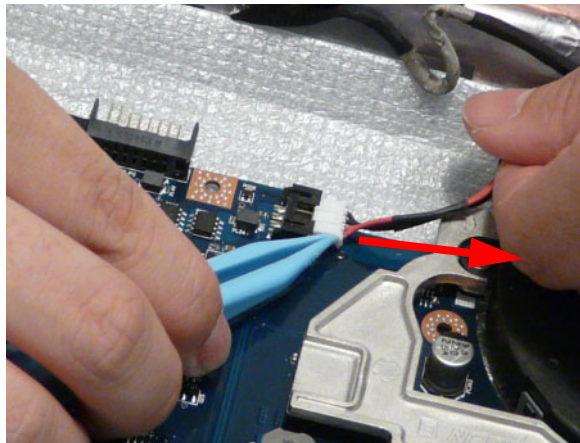

8. Remove the mainboard from the chassis and turn it over.

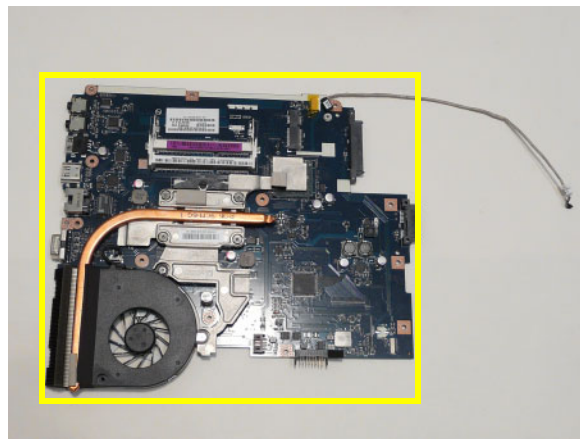

NOTE: Circuit boards >10 cm² have been highlighted with a yellow rectangle as shown in the previous image. Please detach the Circuit board and follow local regulations for disposal.

9. Remove the adhesive tape from the bluetooth cable.

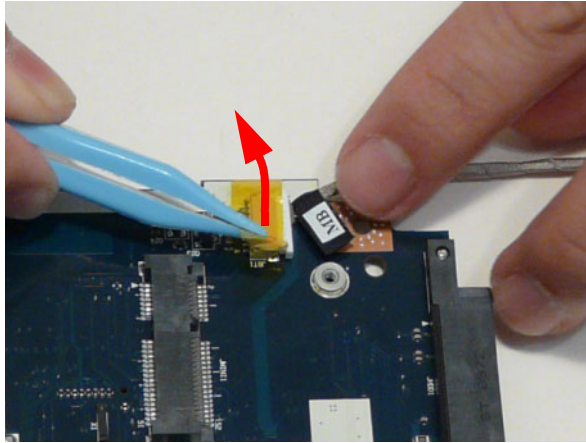

10. Unlock the connector and disconnect the bluetooth to mainboard cable.

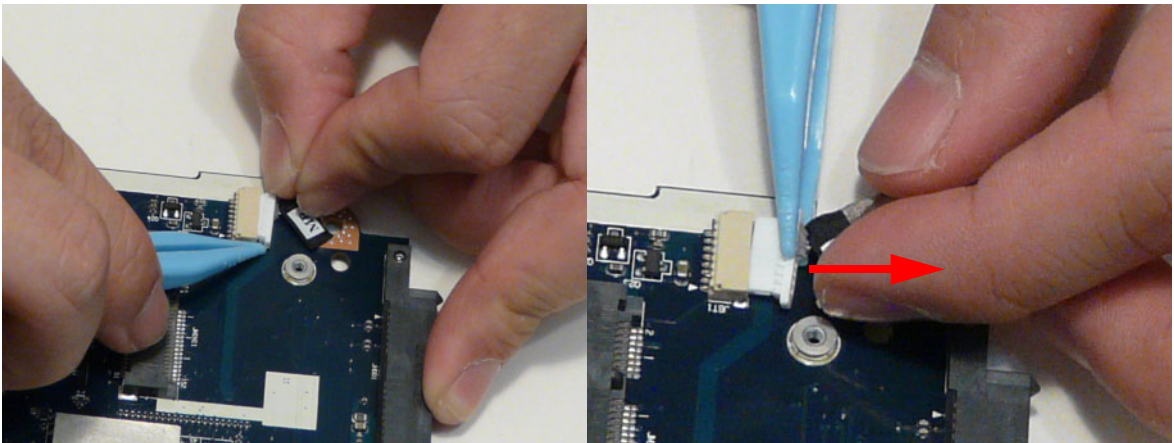

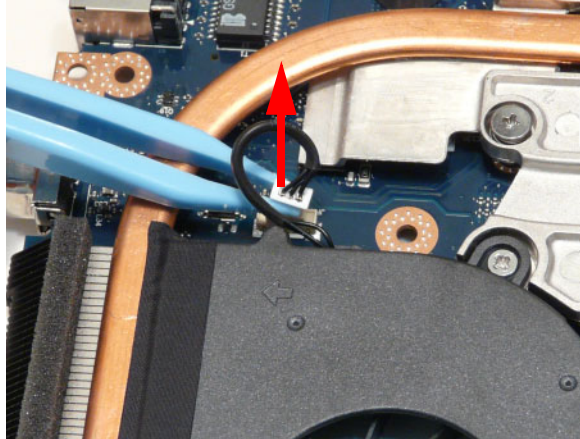

Removing the Thermal Module

1. See "Removing the Upper Cover" on page 62.
2. See "Removing the Mainboard" on page 77.
3. Disconnect the fan cable.

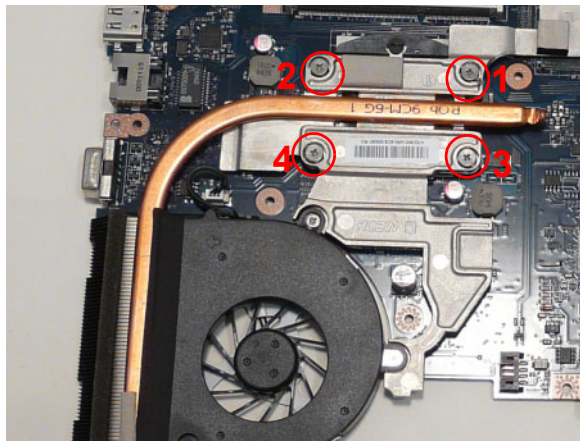

4. Remove the four (4) securing screws (in reverse numerical order from screw 4 to screw 1) from the Thermal Module.



Step	Size	Quantity	Screw Type
Thermal Module	M1.98*3.0	4	

5. Carefully lift the Thermal Module clear of the Mainboard.

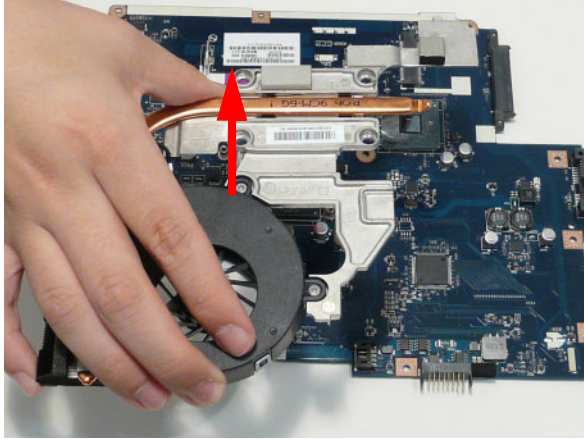

Removing the CPU

IMPORTANT: The pins on the underside of the CPU are very delicate. If they are damaged, the CPU may malfunction. Place the CPU on a clean, dry surface when it is not installed.

1. See “Removing the Thermal Module” on page 81.
2. Using a flat-bladed screw driver, rotate the CPU locking screw 180° clockwise as shown.

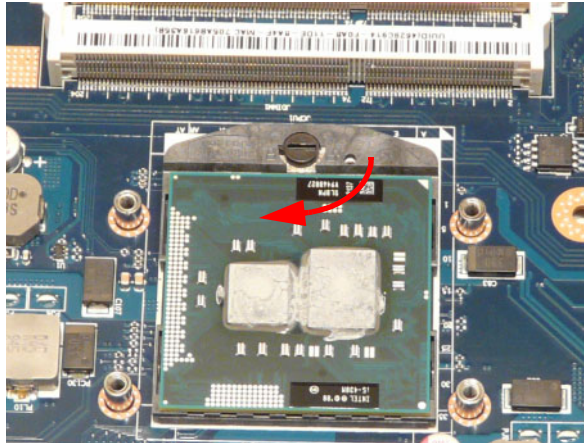

3. Lift the CPU clear of the socket as shown.

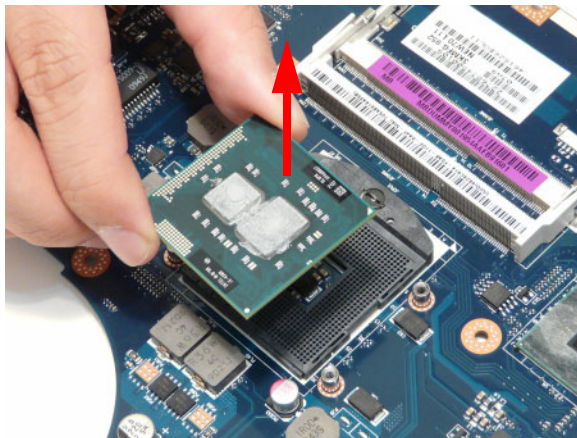

LCD Module Disassembly Process

LCD Module Disassembly Flowchart

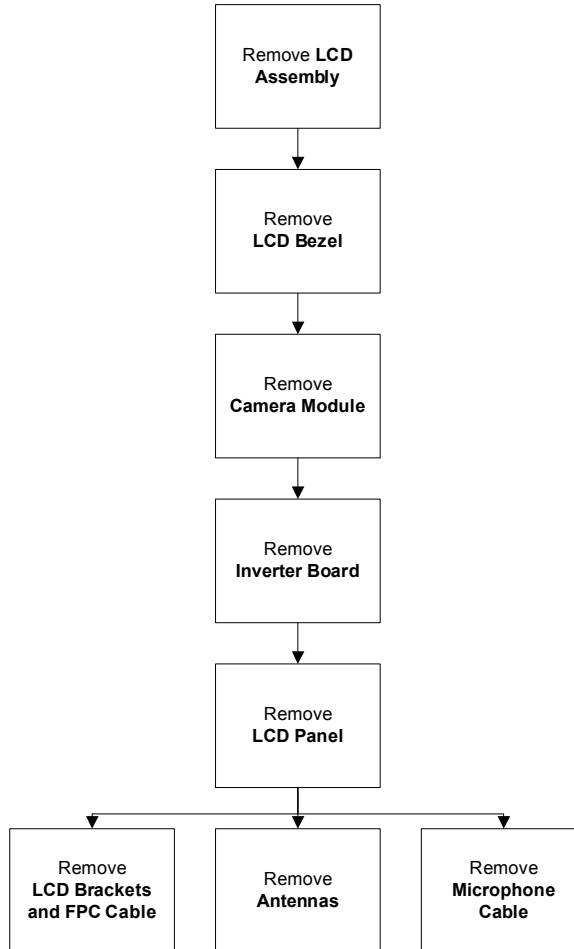

Screw List

Step	Screw	Quantity	Part No.
LCD Bezel	M2.5*6	2	86.WJ802.003
LCD Panel	M2.5*6	2	86.WJ802.003
LCD Brackets	M2*3	6	86.WJ802.004
Inverter Board	M2.5*5	1	86.WJ802.001
LCD Assembly	M2.5*8	4	86.WJ802.002

Removing the LCD Assembly

1. See "Removing the Upper Cover" on page 62.
2. Turn the device over and pass the black and white antenna cables through the lower cover.

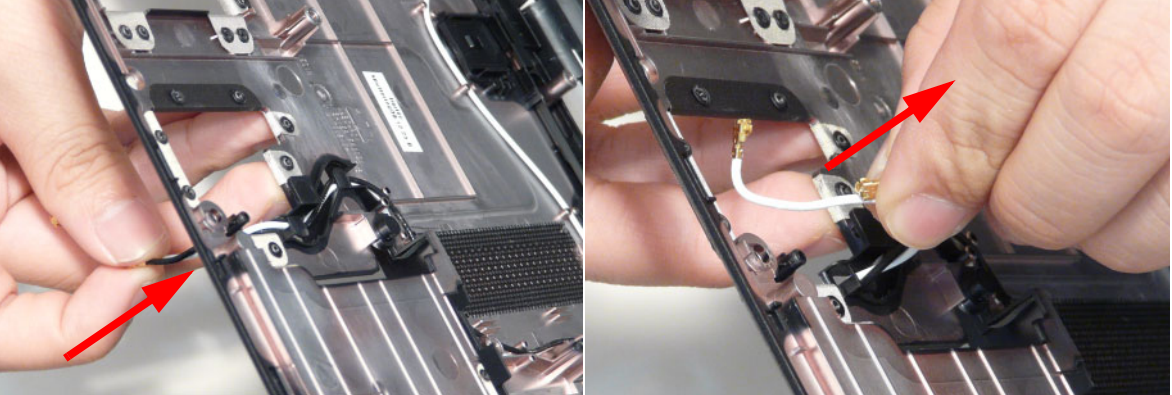

3. Free the black and white antenna cables from the cable channel as shown.

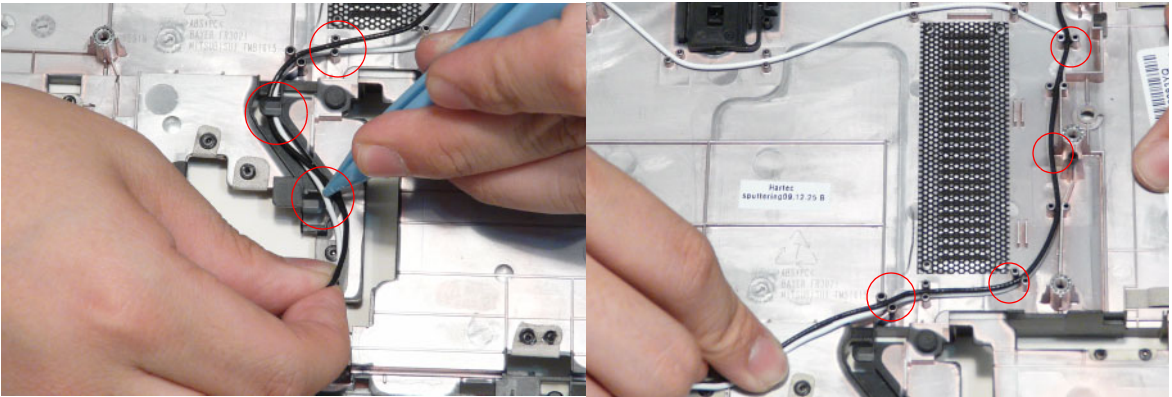

4. Continue removing the white antenna cable from the cable channel.

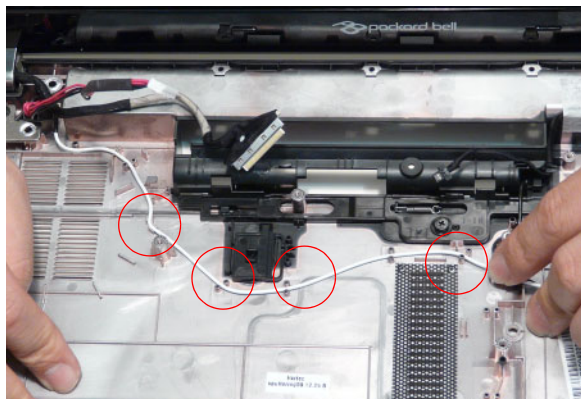

5. Remove the LVDS cable from the cable channel.

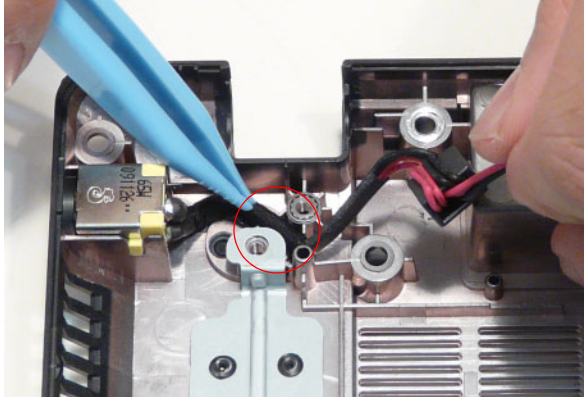

6. Remove the adhesive tape from the black antenna cable and free the cable from the cable channel.

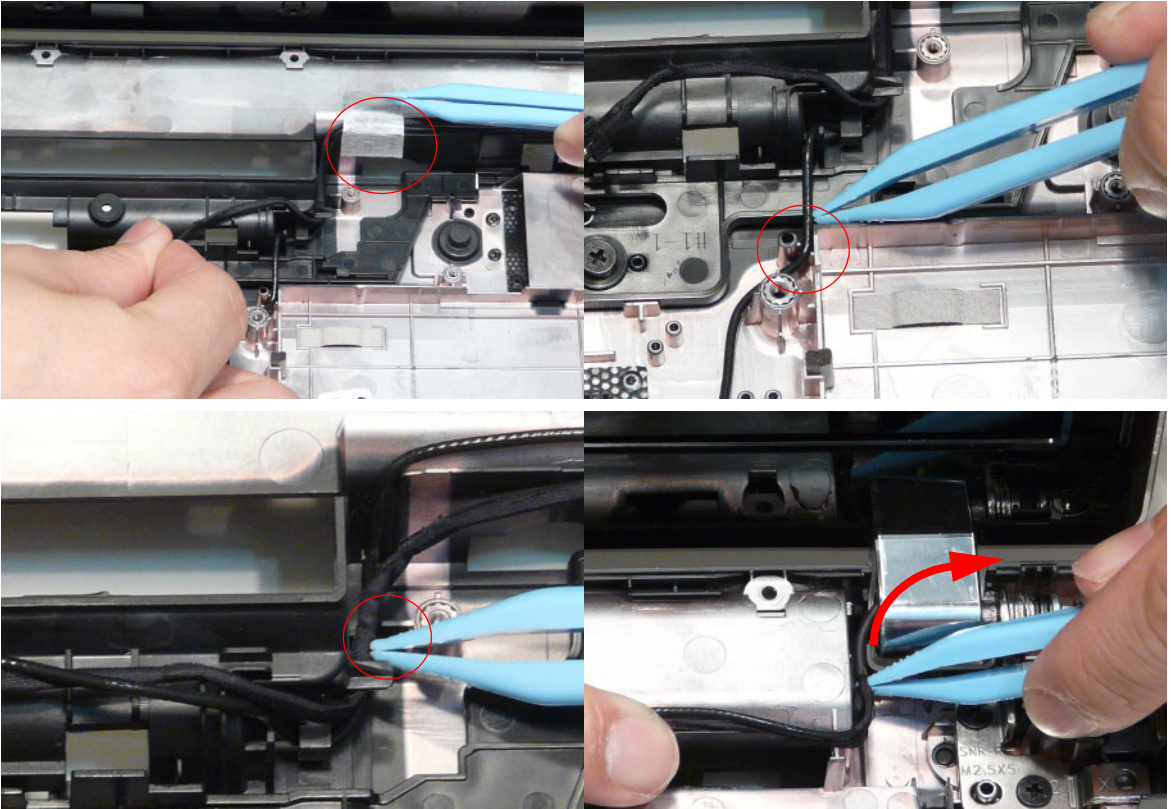

7. Remove four (4) screws from the LCD assembly.

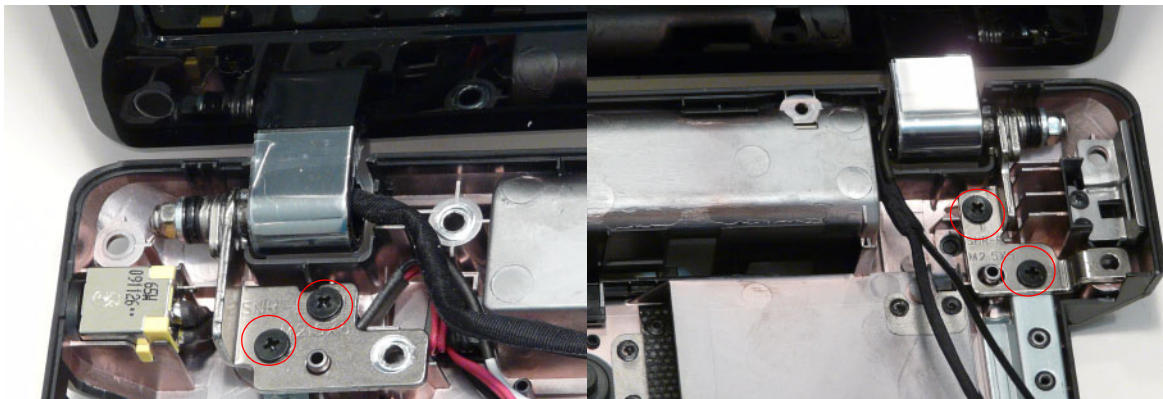

Step	Size	Quantity	Screw Type
LCD assembly	M2.5*8	4	

8. Remove the LCD assembly from the lower cover.

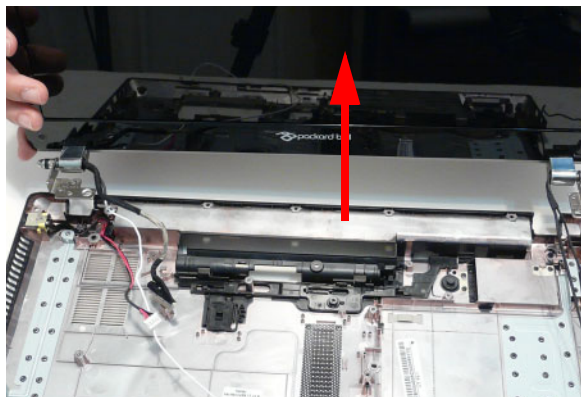

Removing the LCD Bezel

1. See "Removing the LCD Assembly" on page 85.
2. Remove the two (2) bezel screw caps and screws.



Step	Size	Quantity	Screw Type
LCD Bezel	M2.5*6	2	

3. Starting from the bottom edge of the bezel, pry the bezel upwards and away from the panel. Work along the right side toward the top of the bezel, prying the covers apart. Continue along the top edge and down the left side to remove the bezel.

NOTE: If necessary, use a pry to lift up the outside edges of the bezel.



Removing the Camera Module

1. See "Removing the LCD Assembly" on page 85.
2. Locate the Camera Module at the top of the LCD Module and disconnect the camera cable.

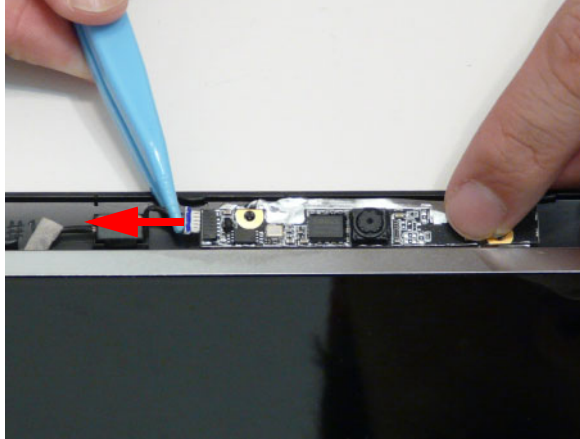

3. Remove the Camera from the module.

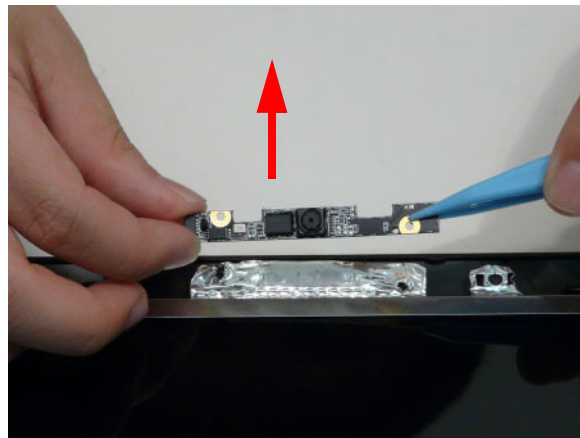

Removing the Inverter Board

1. See "Removing the LCD Assembly" on page 85.
2. Remove the adhesive tape from the inverter cables.

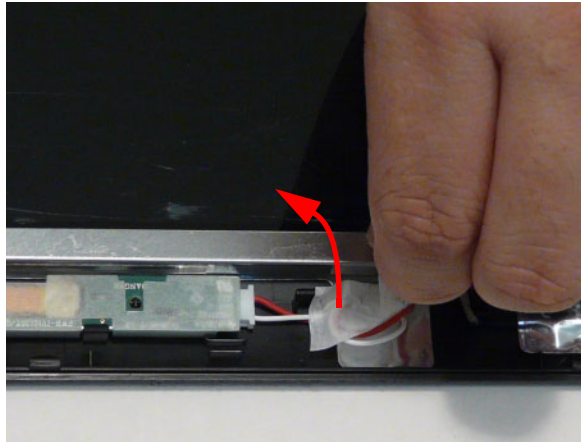

3. Remove one (1) screw from the inverter board.



Step	Size	Quantity	Screw Type
Inverter Board	M2.5*5	1	

4. Using both hands, rotate the inverter board around the hook to free it from the panel.

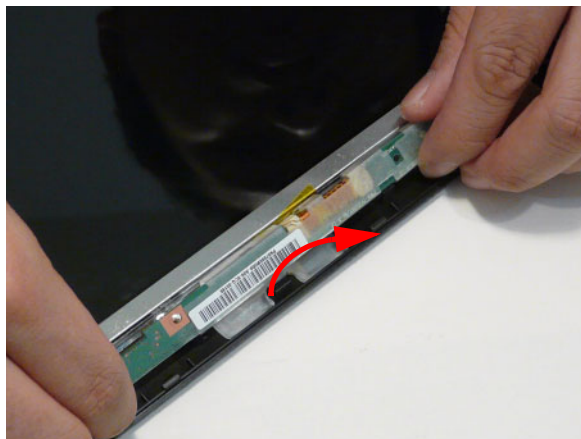

5. Turn the board over and disconnect the cable.

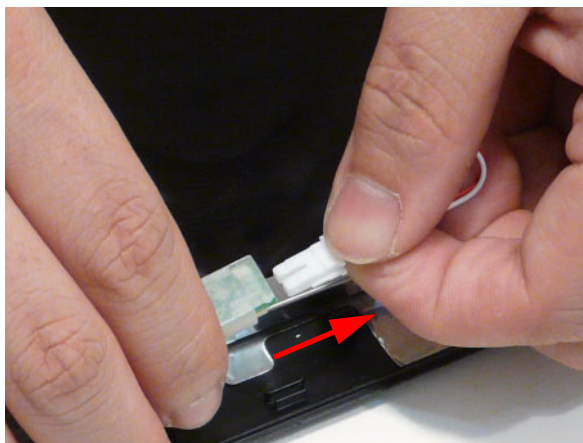

Removing the LCD Panel

- 1. See "Removing the Camera Module" on page 89.
- 2. Remove the two (2) securing screws from the LCD Panel.



Step	Size	Quantity	Screw Type
LCD Panel	M2.5*6	2	

- 3. Remove the adhesive tape from the cable and continue removing the cable from the channel.

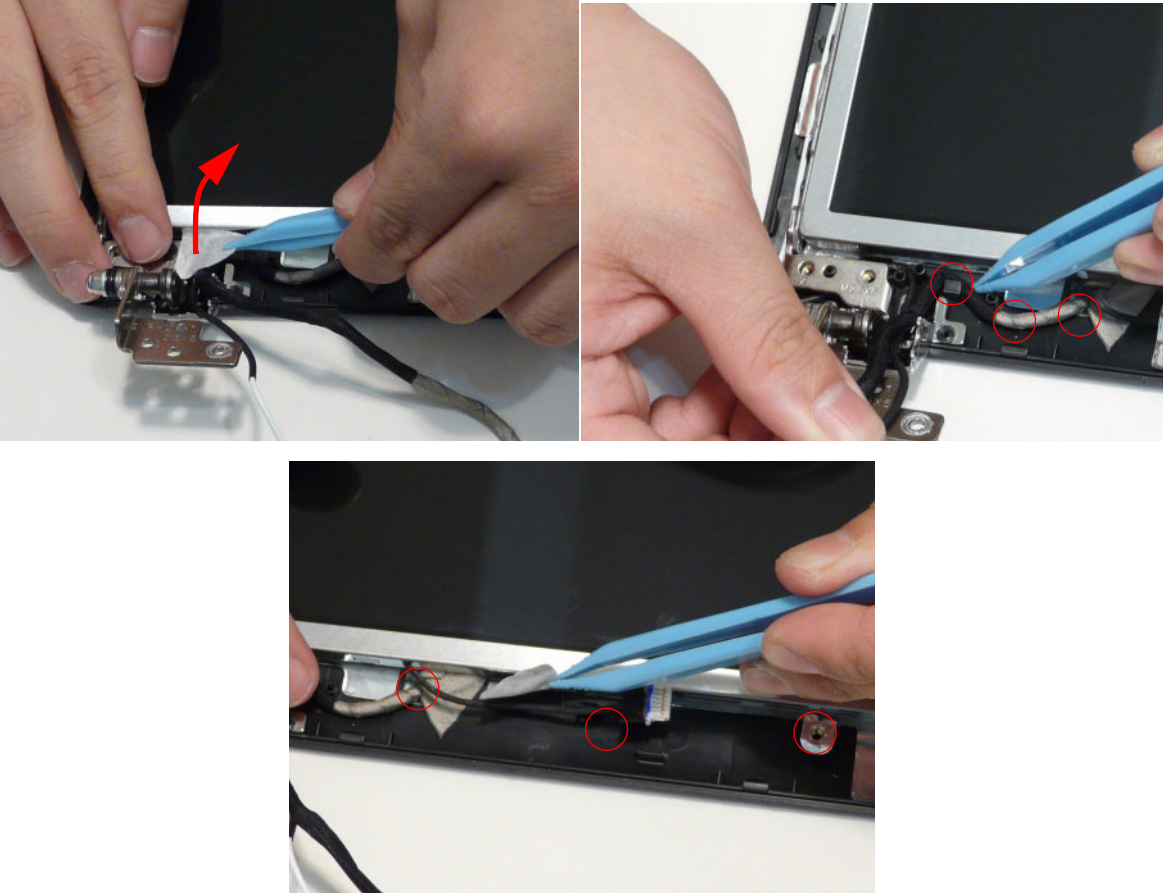



4. Lift the LCD Panel clear of the module.

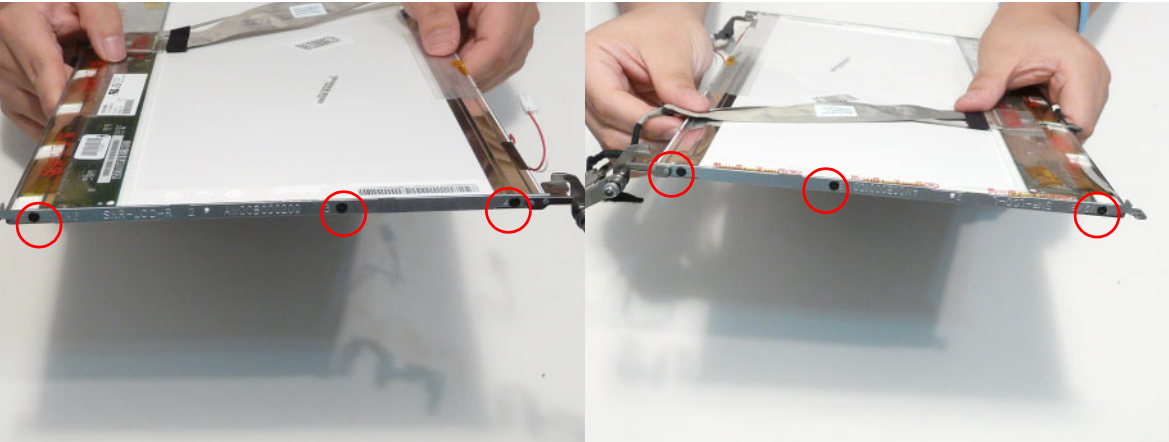

Removing the LCD Brackets and FPC Cable

1. See "Removing the LCD Panel" on page 92.
2. Remove the six (6) securing screws (three on each side) from the LCD Panel brackets.



Step	Size	Quantity	Screw Type
LCD Brackets	M2*3	6	

3. Remove the LCD brackets from the LCD Panel.



4. Peel back the mylar securing the LVDS cable.

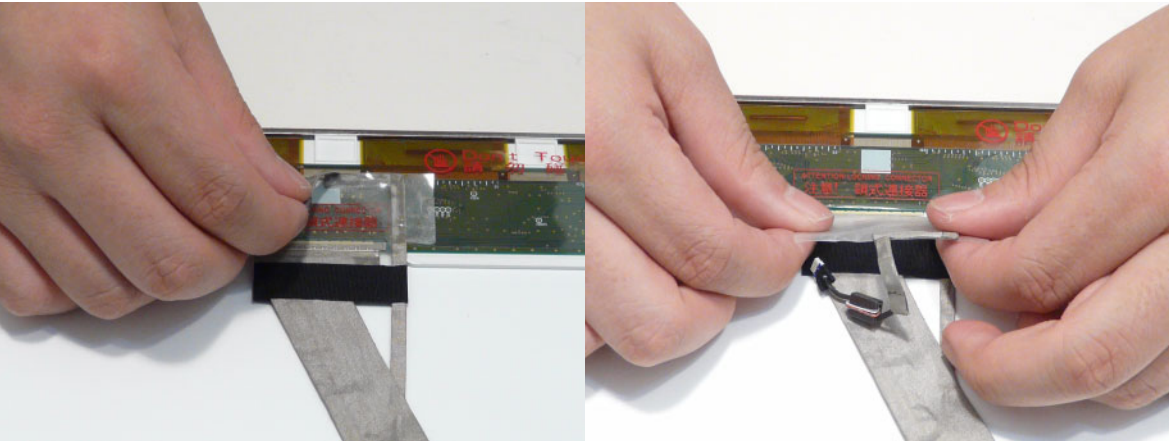

5. Disconnect the LVDS cable from the panel.

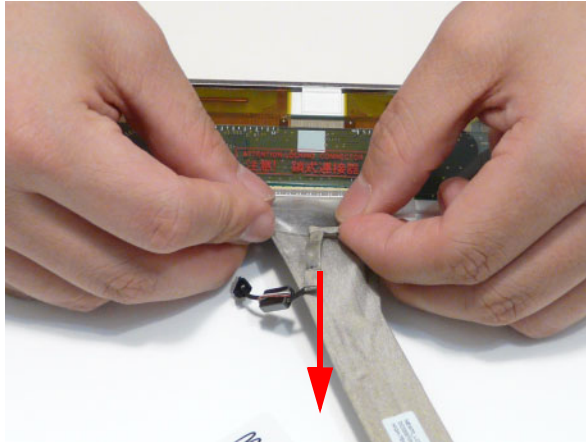

Removing the Microphone Cable

1. See "Removing the LCD Panel" on page 92.
2. Remove the cable bundle from the hinge channel.

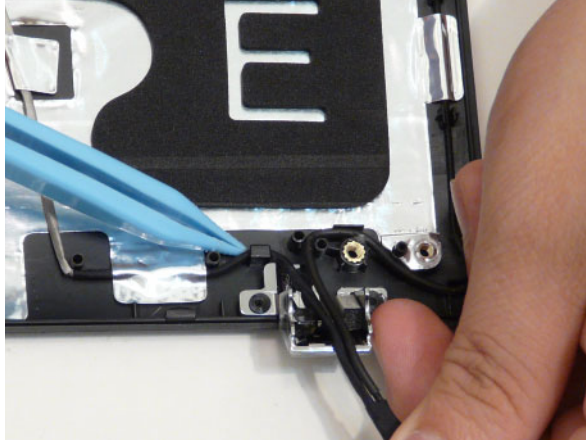

3. Peel back the foil tabs and remove the microphone cable from the cable channel.

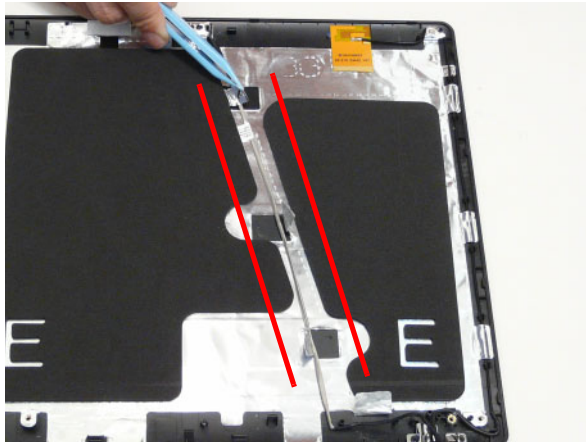

4. Continue removing the cable from the cable channel.

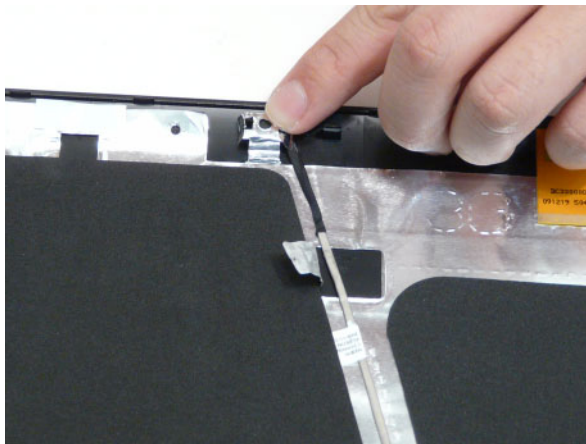

5. Lift the microphone set clear of the panel.

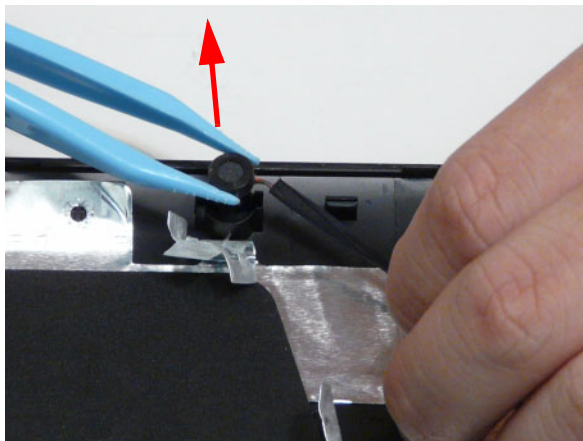

Removing the Antennas

1. See “Removing the LCD Panel” on page 92.
2. Remove the black antenna from the cable channel.

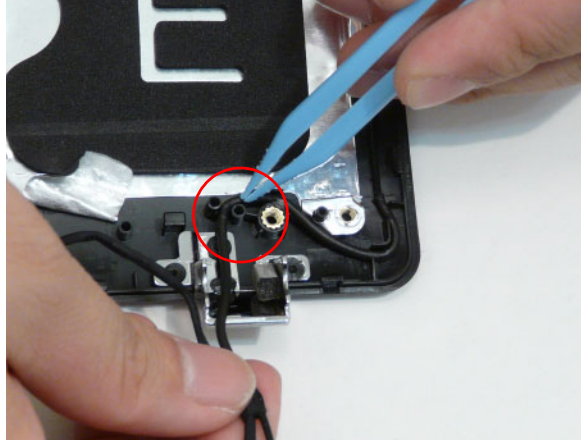

3. Peel back the foil tabs and remove the cable from the cable channel.



4. Pry the antenna assembly clear of the device.

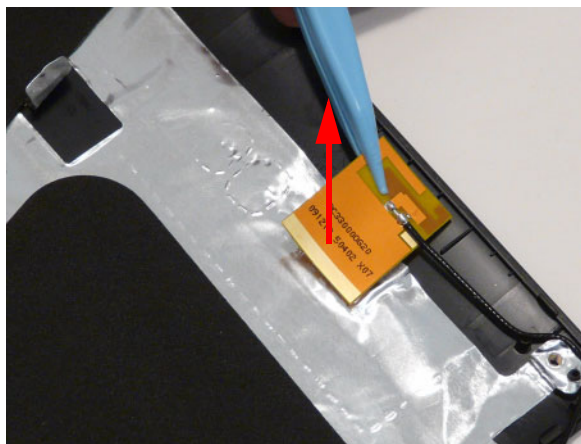

5. Remove the white antenna from the hinge channel.

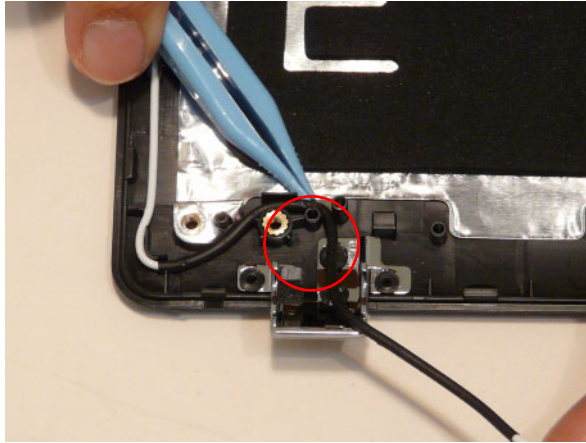

6. Peel back the foil tabs and remove the cable from the cable channel.

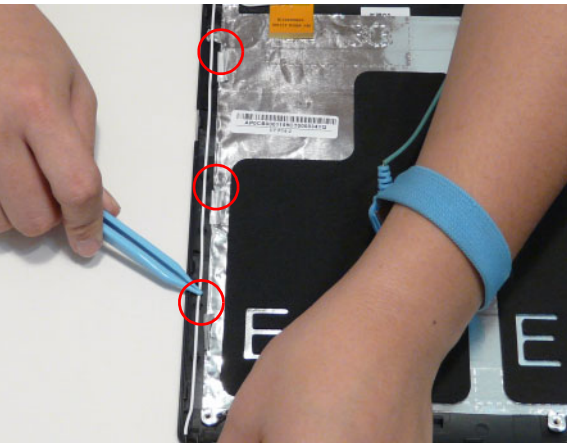

7. Pry the antenna assembly clear of the device.

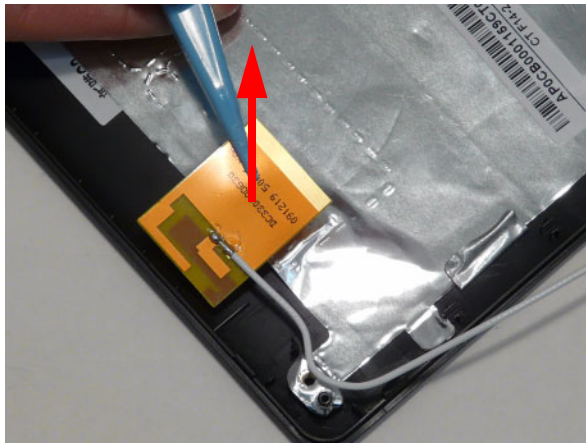

LCD Module Reassembly Procedure

Replacing the Antennas

1. Adhere the white antenna assembly to the LCD cover.

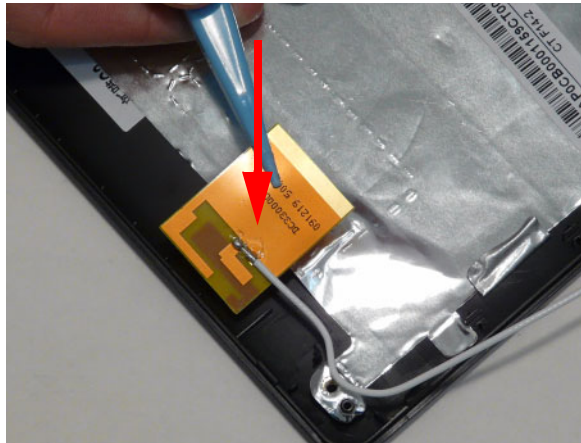

2. Run the cable along the cable channel and fold over the foil tabs to secure the cable in place.

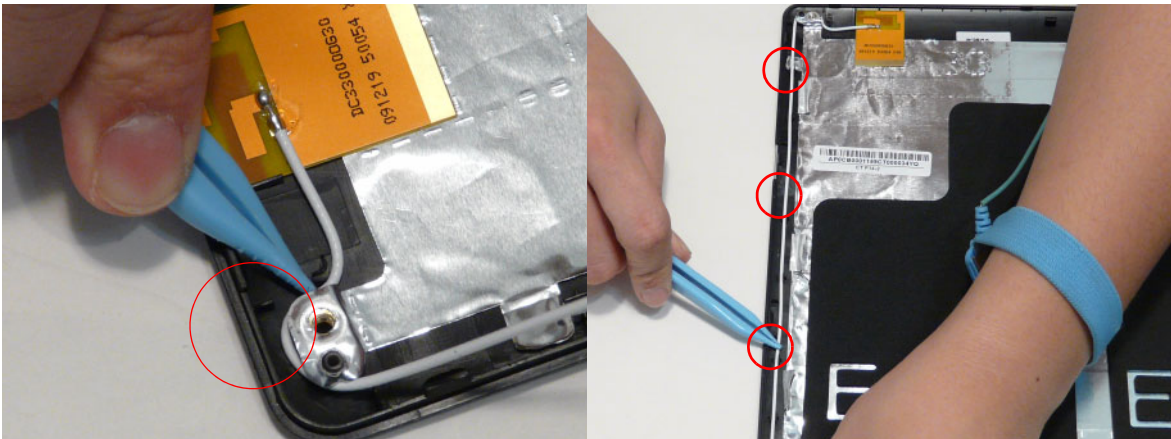

3. Run the white antenna along the hinge channel.

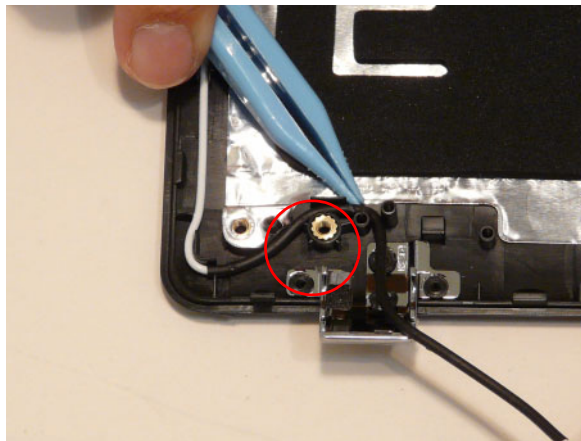

4. Adhere the black antenna assembly on the LCD cover.

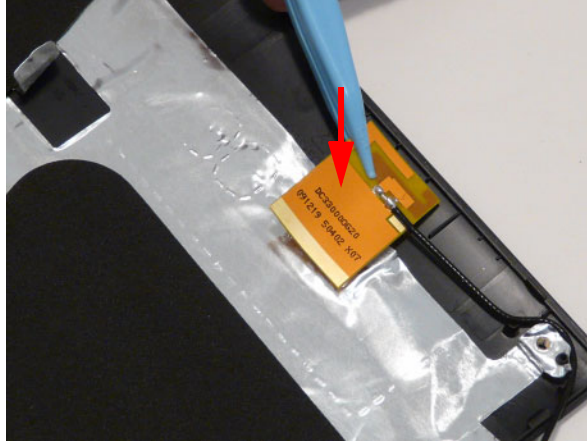

5. Run the cable along the cable channel and fold over the foil tabs to secure the cable in place.

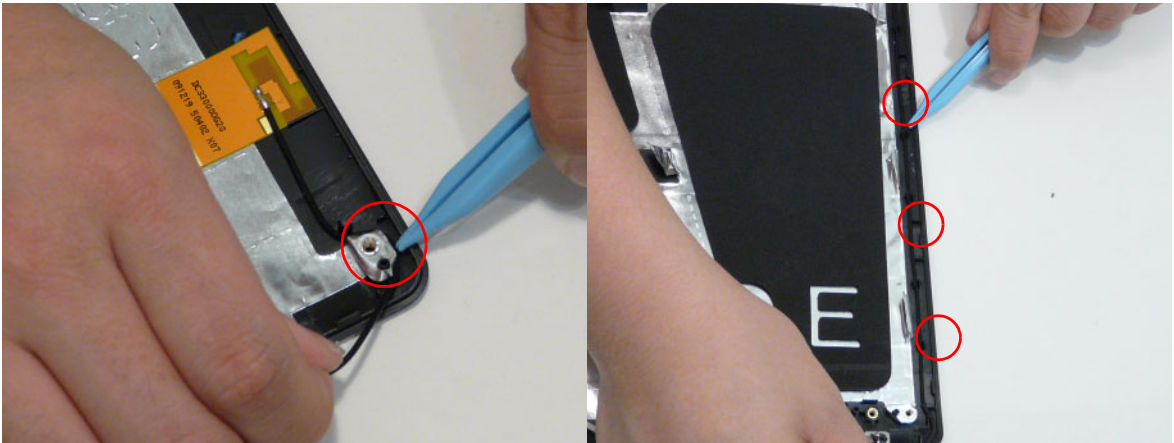

6. Run the black antenna cable along the cable channel.

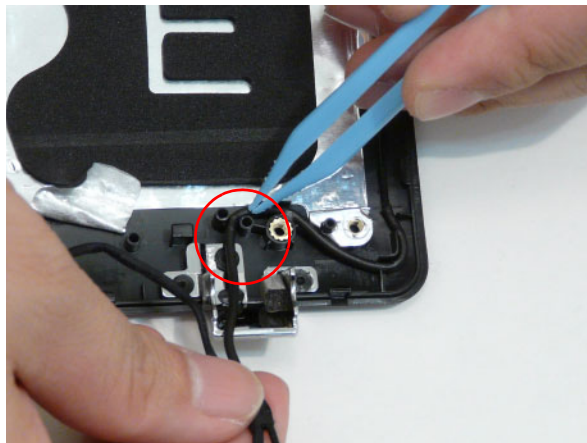

Replacing the Microphone Cable

1. Place the microphone set in the panel.

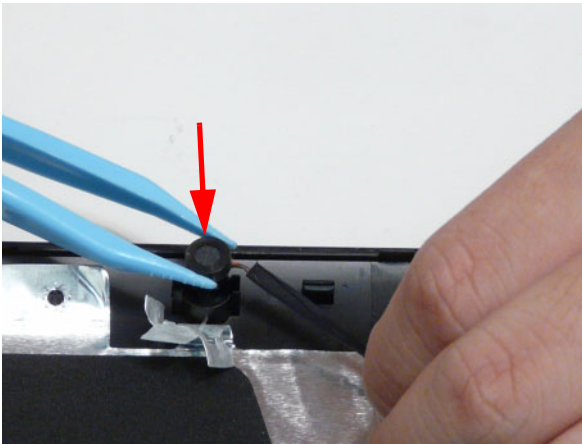

2. Fold the foil tab over to secure.

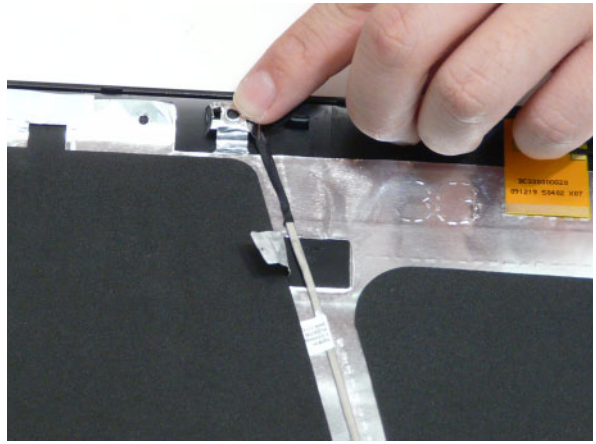

3. Fold over the foil tabs and continue running the microphone cable along the cable channel indicated between the red callouts.

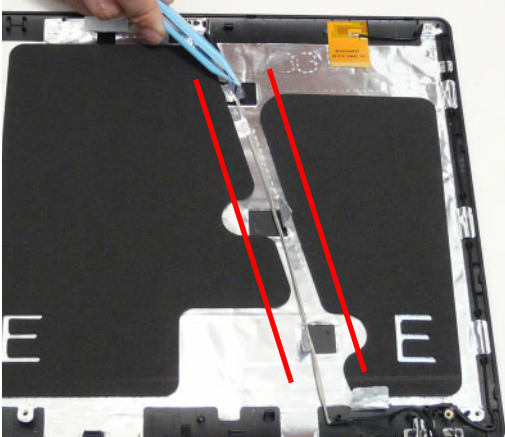

4. Run the cable bundle along the hinge channel.

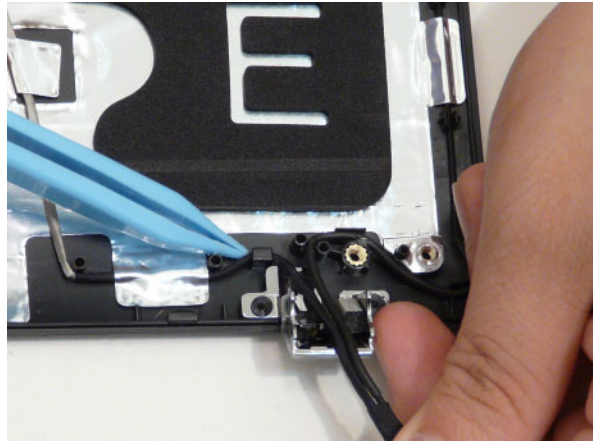

IMPORTANT: Ensure that the LCD cable runs between the callouts to avoid trapping when the panel is replaced in the LCD Module.

Replacing the LCD Brackets and FPC Cable

1. Connect the LVDS cable to the LCD panel.

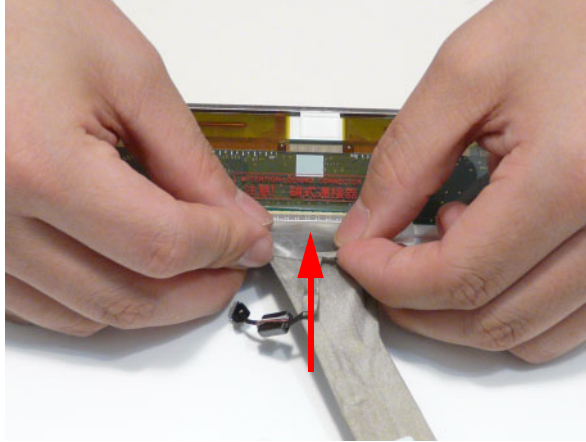

2. Adhere the LVDS mylar to the LCD panel.

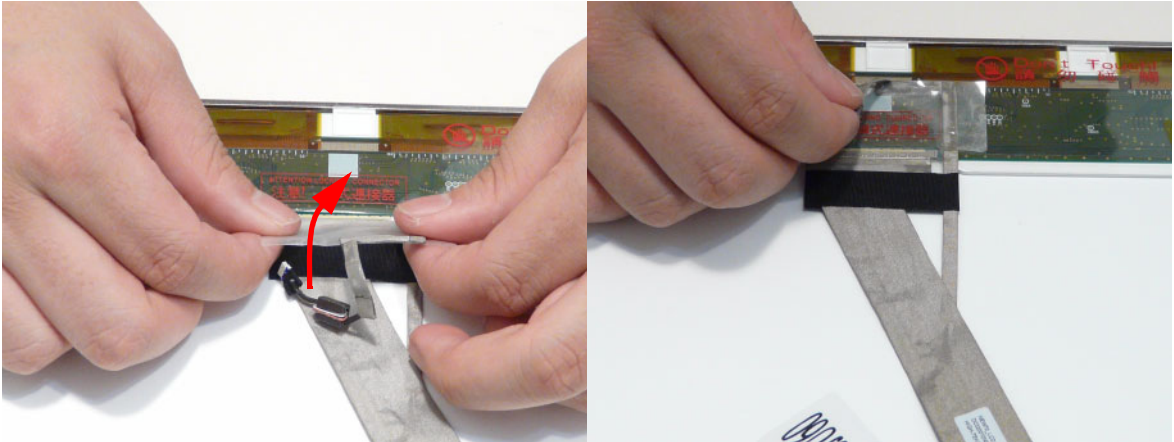

3. Attach the LCD brackets to the LCD Panel.



4. Replace six (6) securing screws (three on each side) of the LCD Panel brackets.

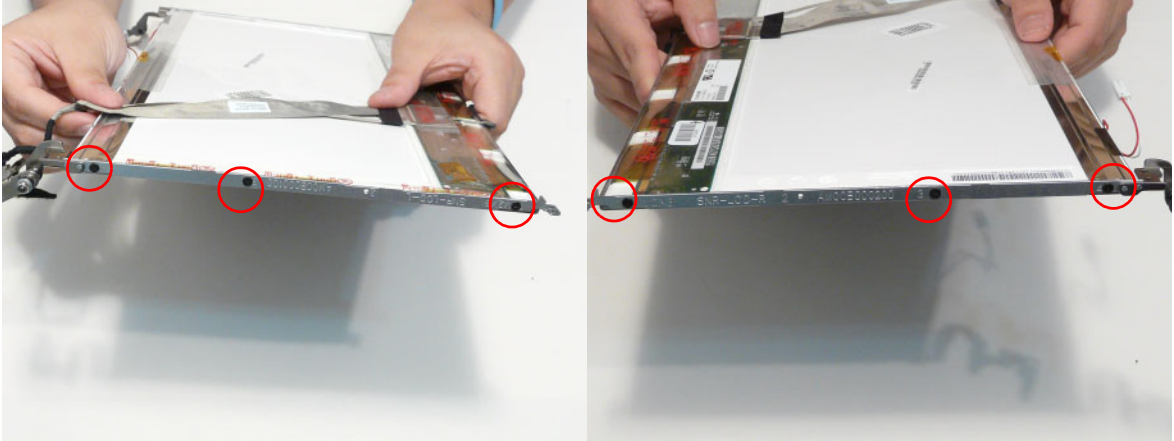

Replacing the LCD Panel

1. Place the LCD Panel in the module.
2. Run the cable along the channel in the LCD Module as shown.

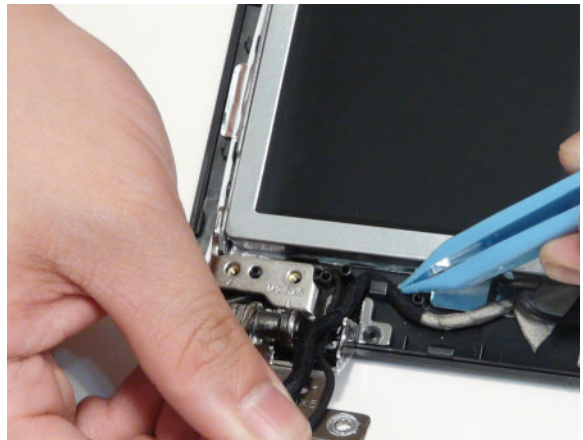

3. Apply the adhesive strip to hold the cable in place.
4. Secure the panel using two (2) securing screws.

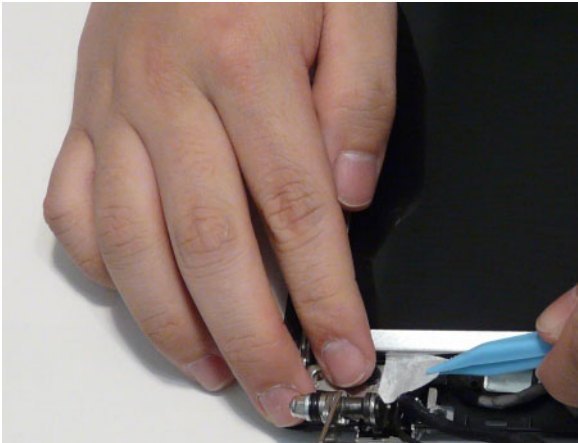

Replacing the Inverter Board

1. Place the LCD Panel in the module.
2. Run the cable along the channel in the LCD Module as shown.

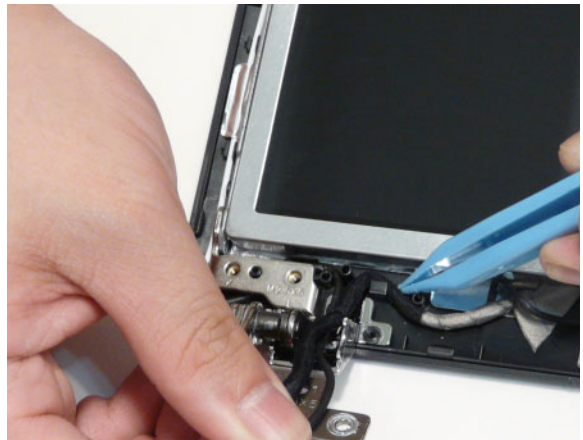

3. Apply the adhesive strip to hold the cable in place.
4. Secure the panel using two (2) securing screws.

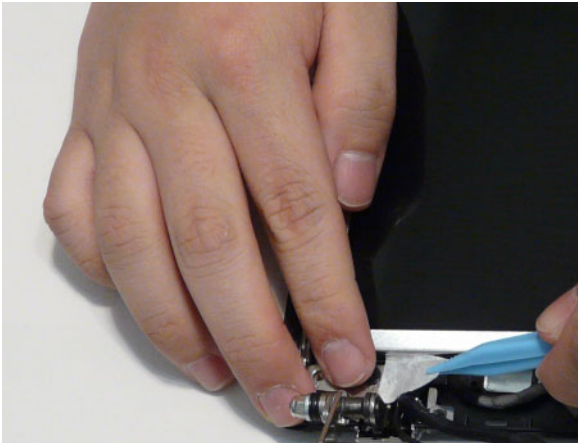

Replacing the Camera Module

1. Place the Camera in the module.

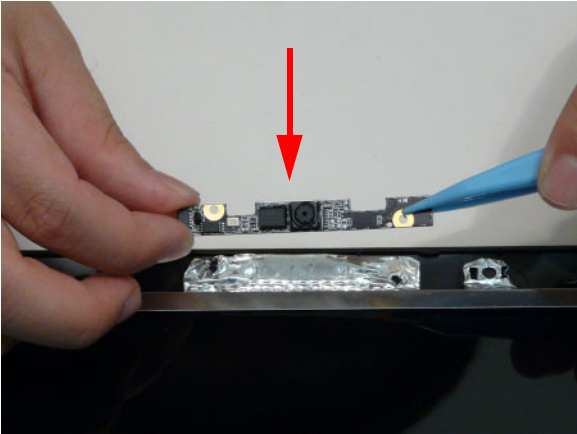

2. Connect the camera cable.

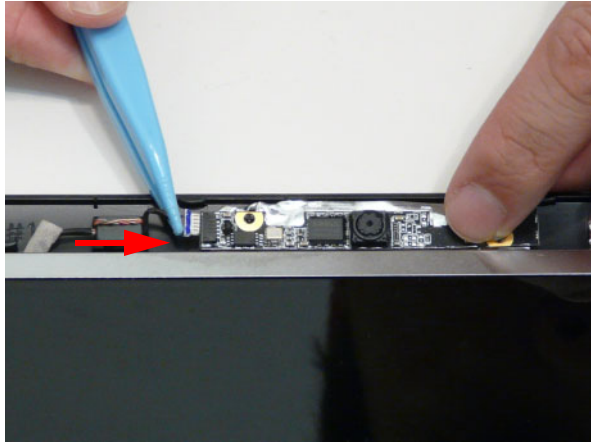

Replacing the LCD Bezel

1. Replace the bezel and press down until there are no gaps between the bezel and the LCD Module.

IMPORTANT: Ensure that the LCD cables pass through the hinge wells and are not trapped by the bezel.



2. Replace the two (2) screws and screw caps.



Replacing the LCD Assembly

1. Place the LCD assembly on the lower cover.

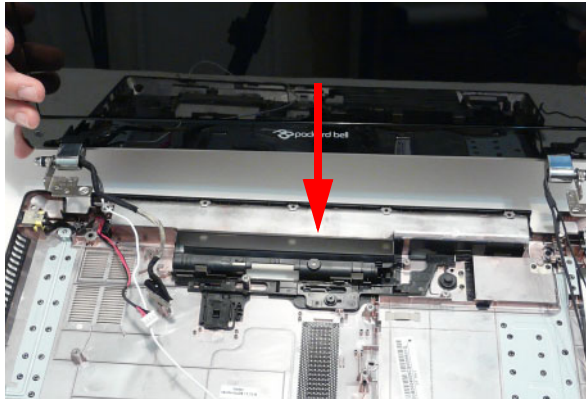

2. Secure the LCD assembly using four (4) screws.

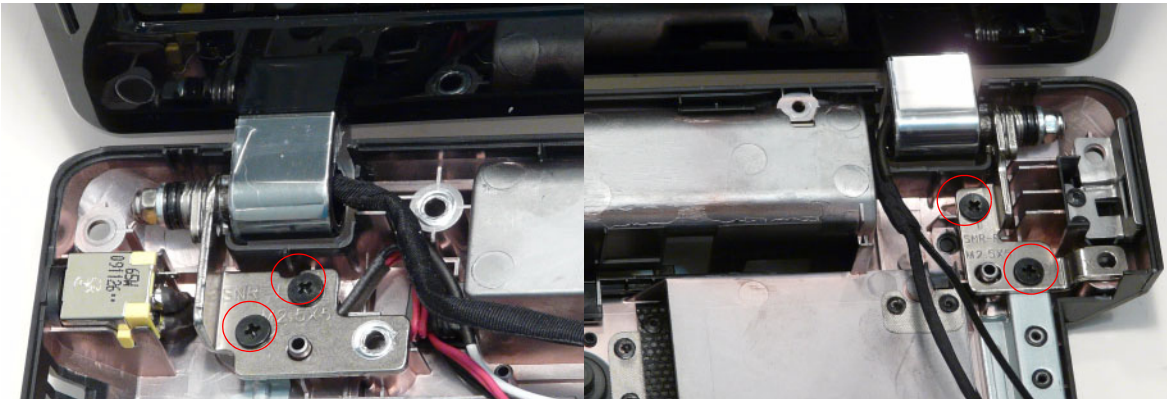

3. Replace the adhesive tape and run the black antenna cable along the cable channel.

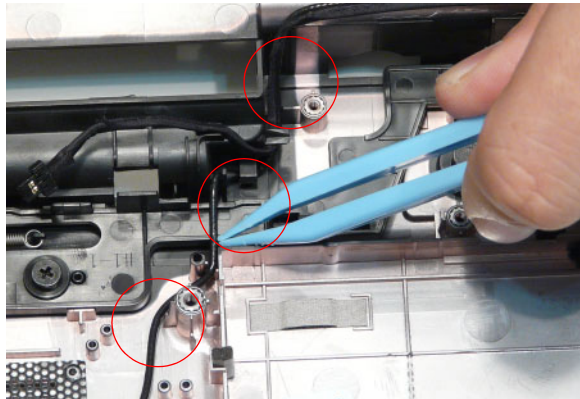
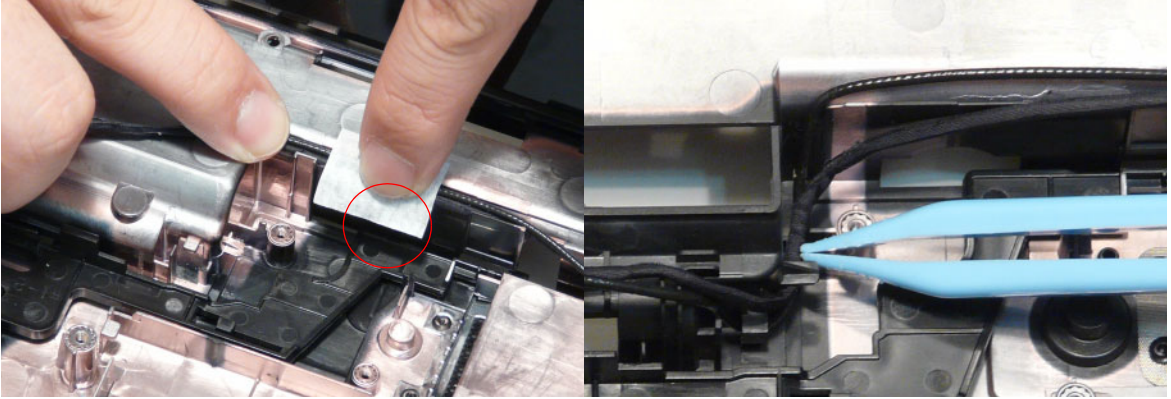

4. Near the left hinge, run the LVDS cable along the cable channel.

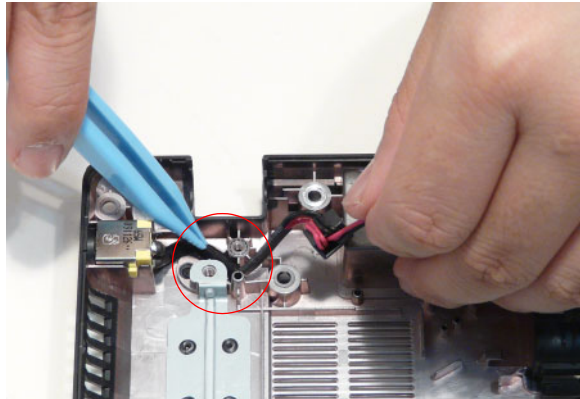

5. Run the white antenna cable along the cable channel as shown.

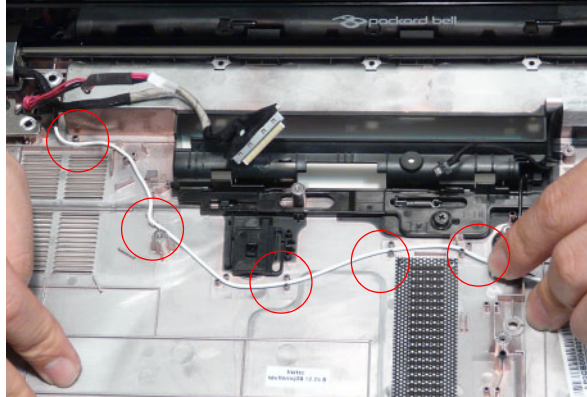

6. Run the black antenna cables along the cable channel.

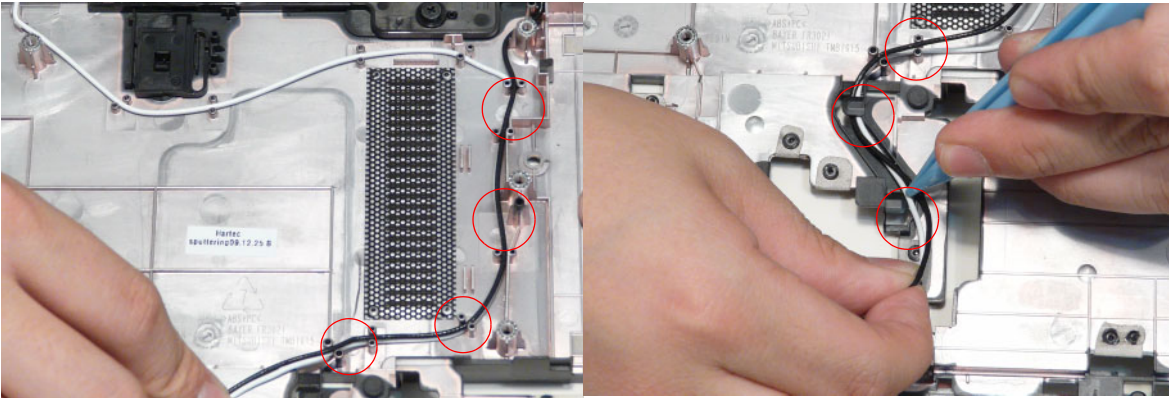

7. Pass the black and white antenna cables through the lower cover.

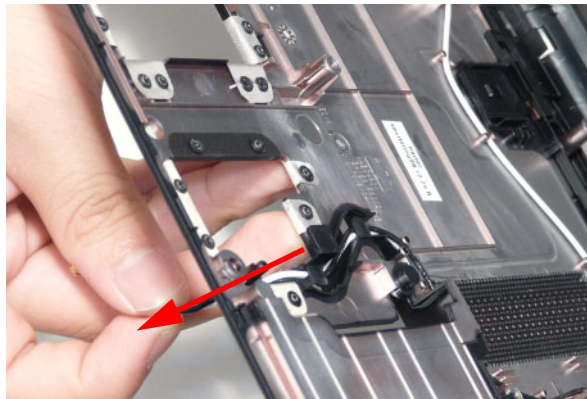

Main Module Reassembly Procedure

Replacing the CPU

IMPORTANT: The CPU has a Pin1 locator that must be positioned corresponding to the marker on the CPU socket.

1. Place the CPU into the CPU socket as shown, taking note of the Pin1 locator.

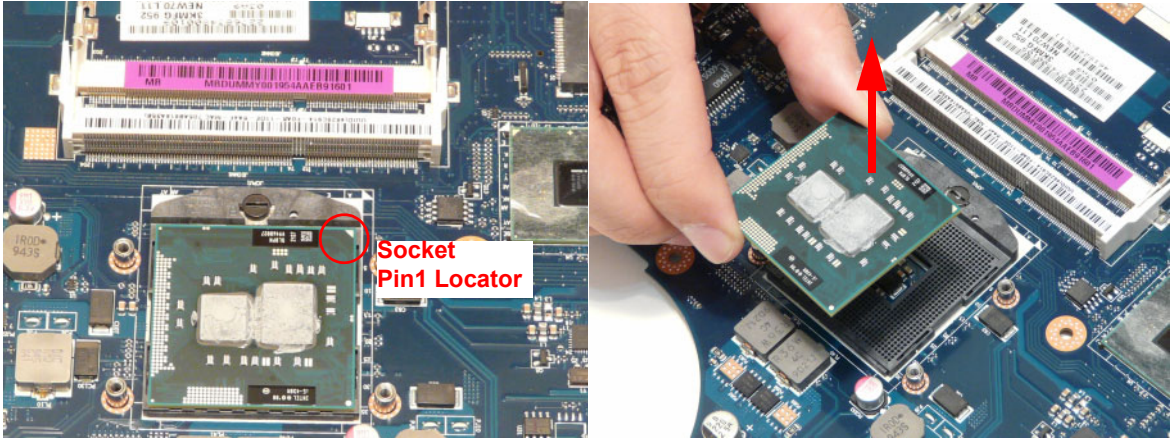

2. Using a flat-bladed screw driver, rotate the CPU locking screw 180° counter-clockwise to secure the CPU in place.

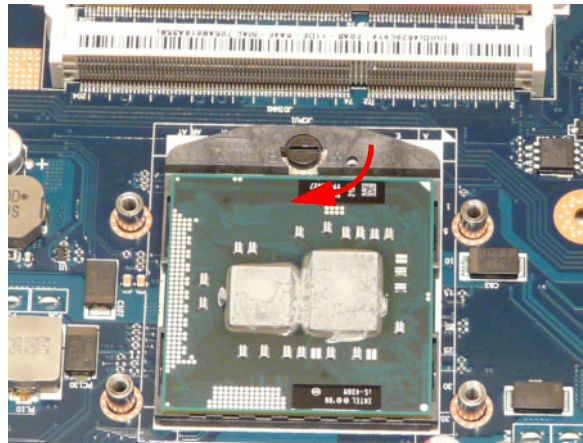

Replacing the Thermal Module

IMPORTANT: Apply a suitable thermal grease and ensure all heat pads are in place before replacing the Thermal Module.

The following thermal grease types are approved for use:

- Silmore GP50
- Honeywell
- Jet Motor 7762

The following thermal pads are approved for use:

- Eapus XR-PE
1. Remove all traces of thermal grease from the CPU using a lint-free cloth or cotton swab and Isopropyl Alcohol, Acetone, or other approved cleaning agent.
 2. Apply a small amount of thermal grease to the centre of the CPU—there is no need to spread the grease manually, the force used during the installation of the Thermal Module is sufficient.
 3. Align the screw holes on the Thermal Module and Mainboard then replace the module. Keep the module as level as possible to spread the thermal grease evenly.
 4. Replace the four (4) securing screws (in numerical order from screw 1 to screw 4) to secure the Thermal Module in place.

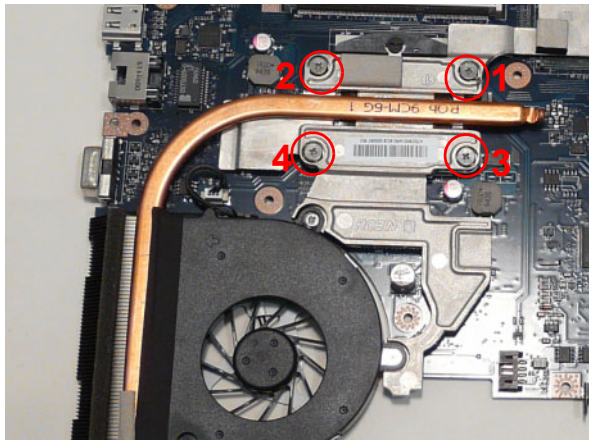
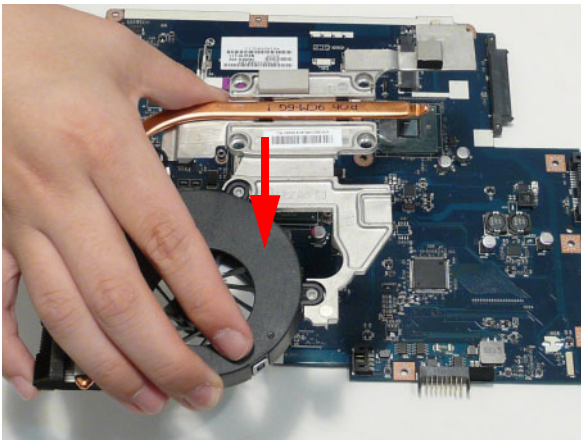

5. Connect the fan cable.

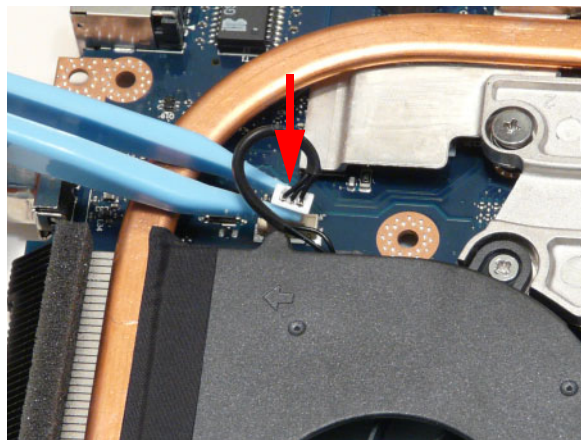

Replacing the Mainboard

1. Connect the Bluetooth to mainboard cable.

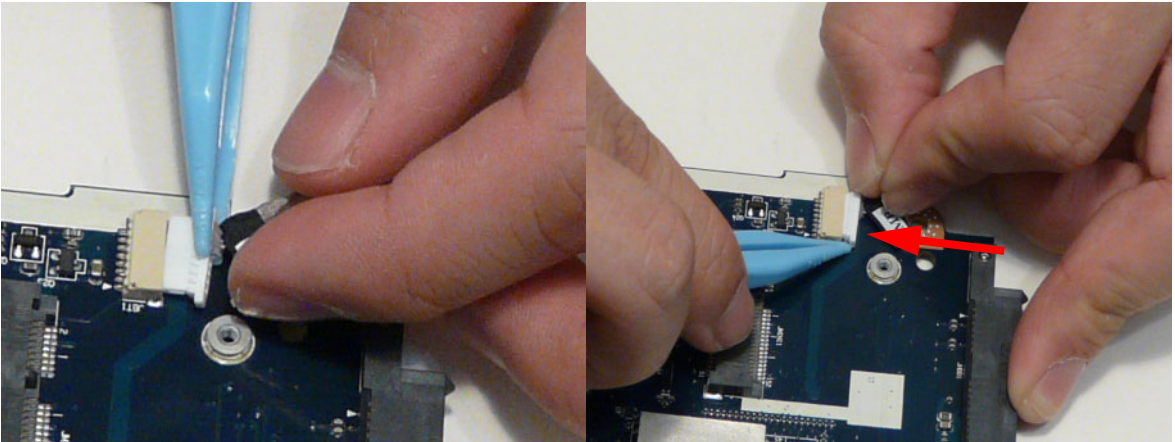

2. Apply the adhesive tape to the Bluetooth cable.

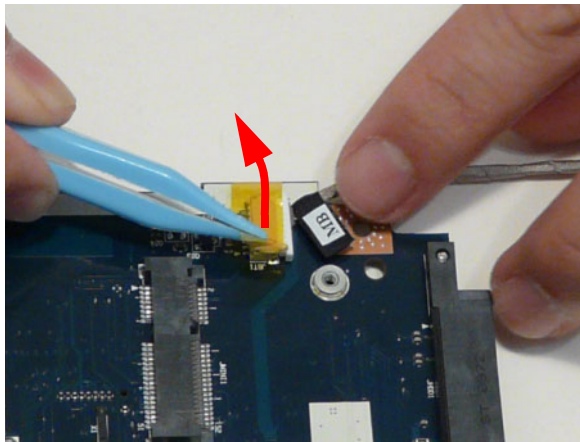

3. Place the mainboard on a clean, dust-free surface. Connect the power cable.

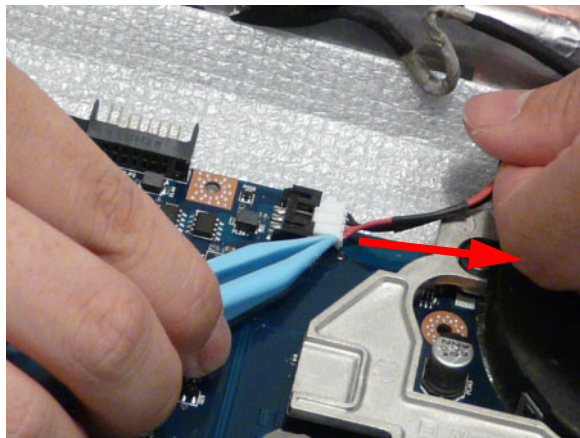

NOTE: Ensure the I/O ports are positioned correctly through the casing.

4. Place the mainboard in the chassis, left edge first to line up the I/O ports.

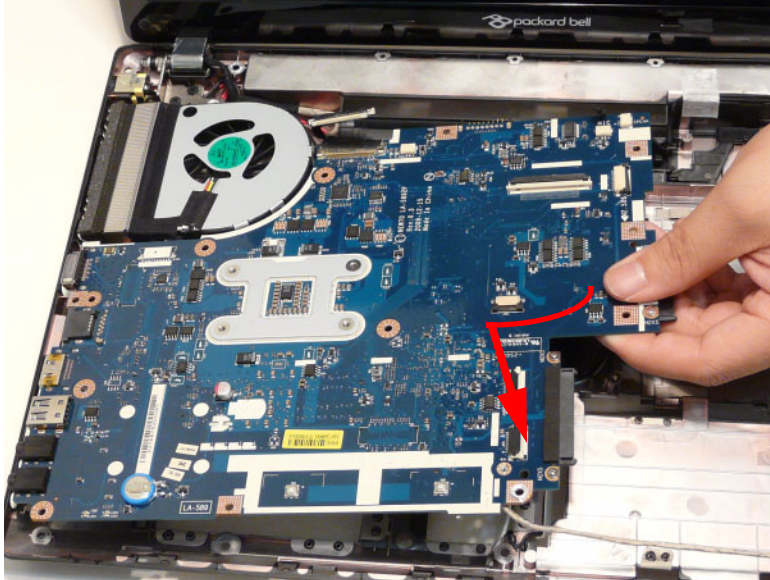

5. Secure the one (1) securing screw on the Mainboard.

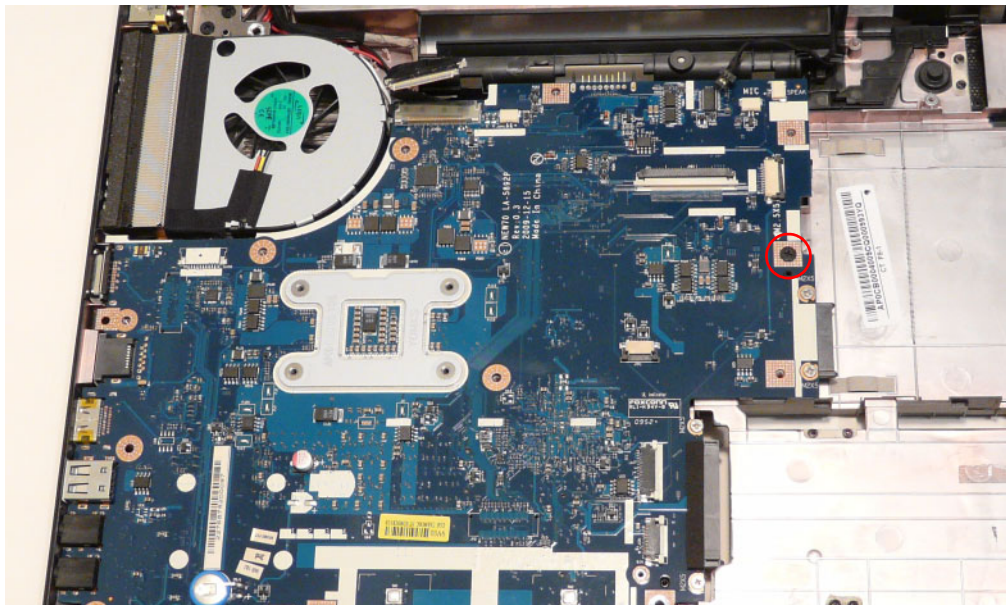

6. Connect the LVDS cable and lock the connector.

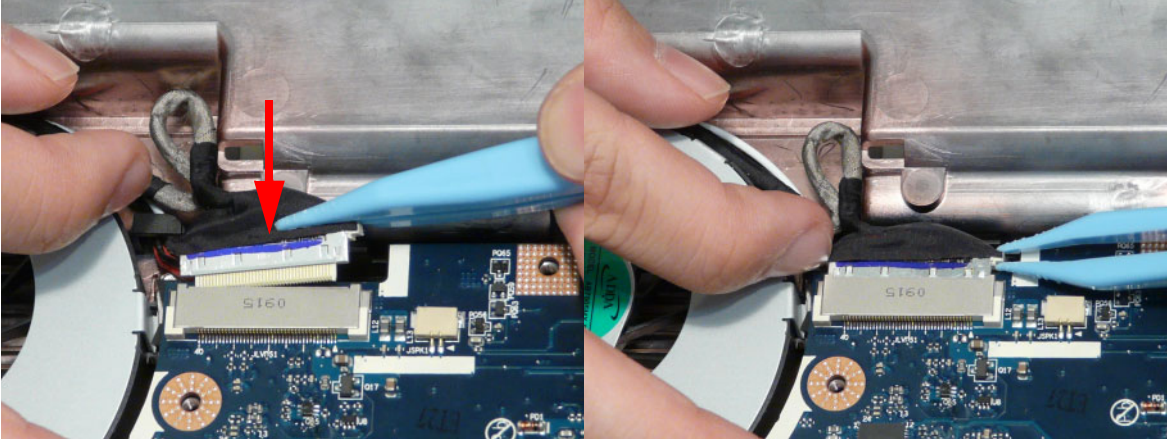

7. Connect the microphone cable.

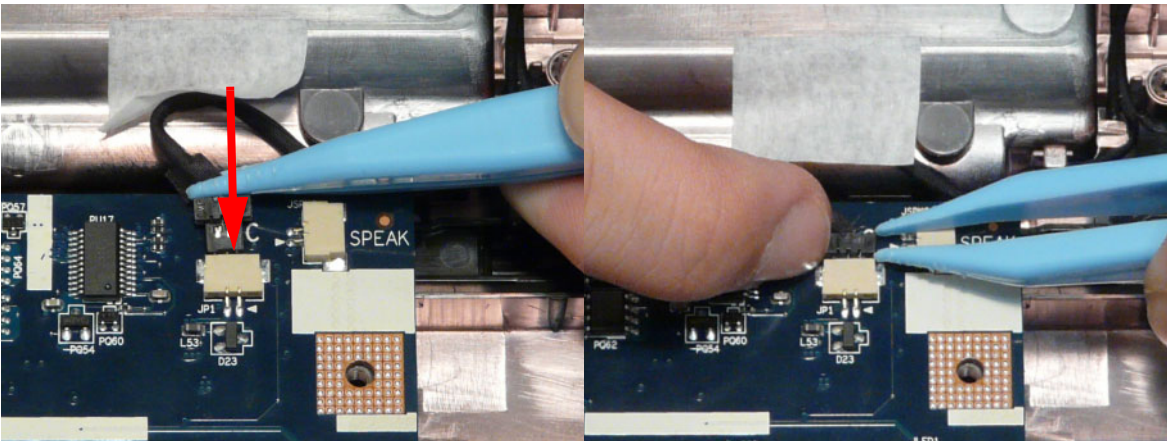

Replacing the Bluetooth Board

1. Run the bluetooth cable along the channel as shown.

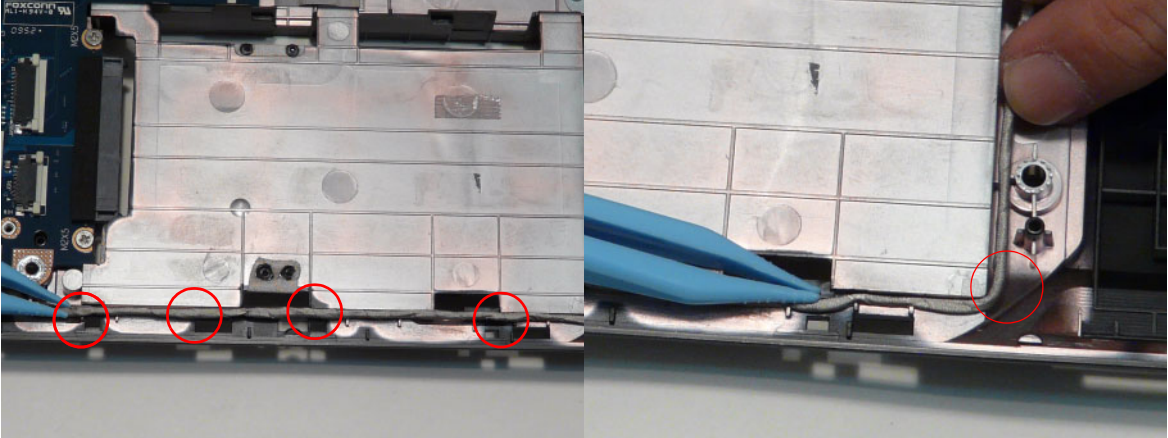

2. Connect the mainboard to bluetooth cable.

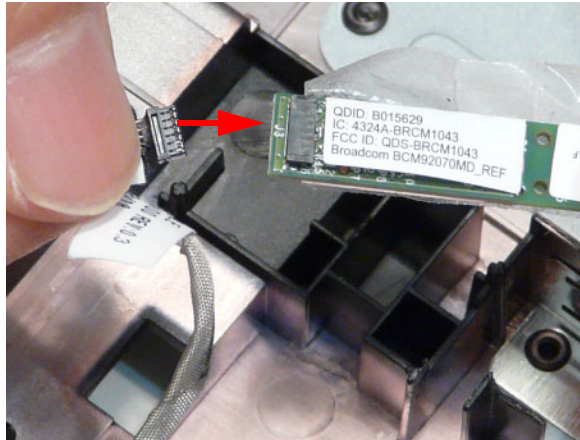

3. Adhere the bluetooth board to the adhesive.

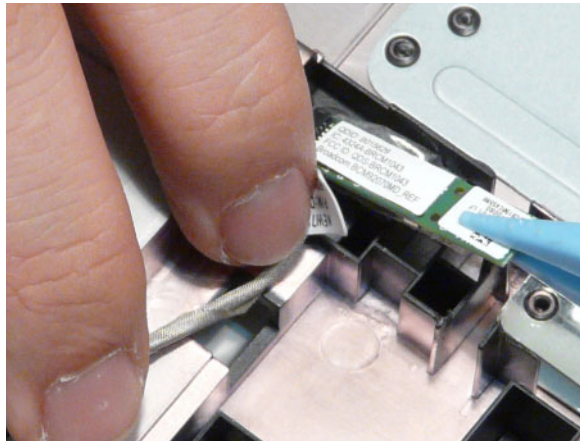

Replacing the USB Board

1. Place the USB board in the device.

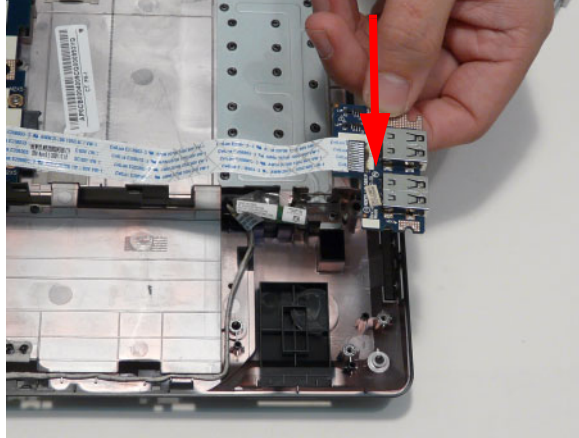

2. Secure the one (1) screw on the USB board.

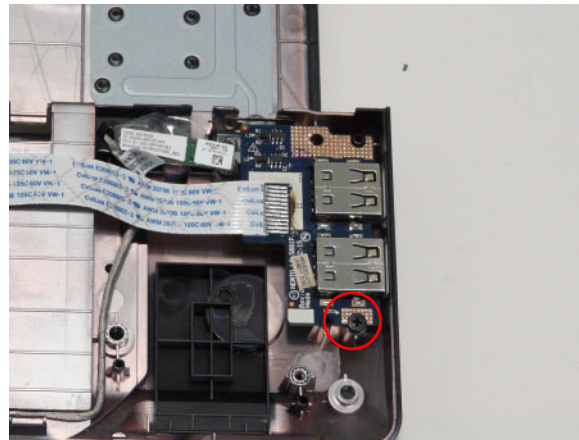

3. Connect the USB cable to the mainboard and lock the connector.

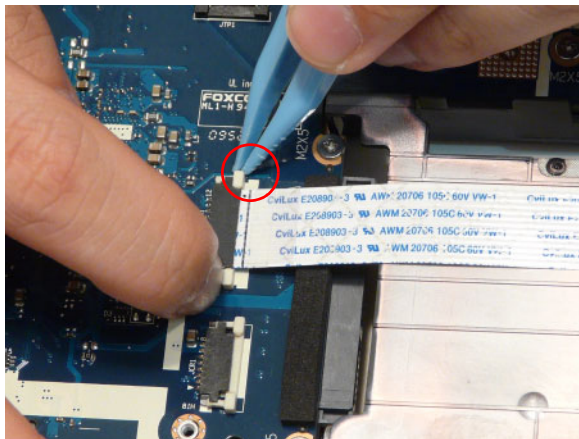

Replacing the Card Reader Board

1. Place the card reader board in the device.

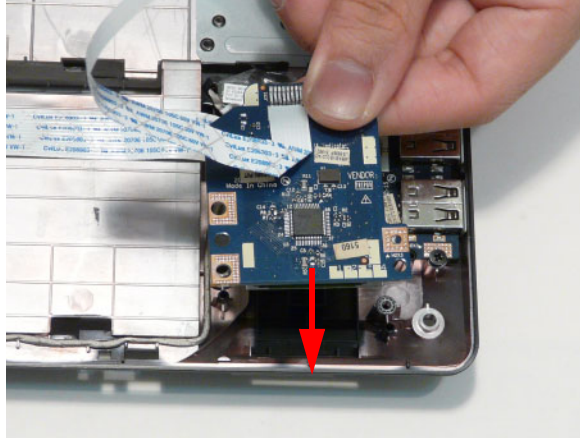

2. Secure one (1) screw on the card reader board.

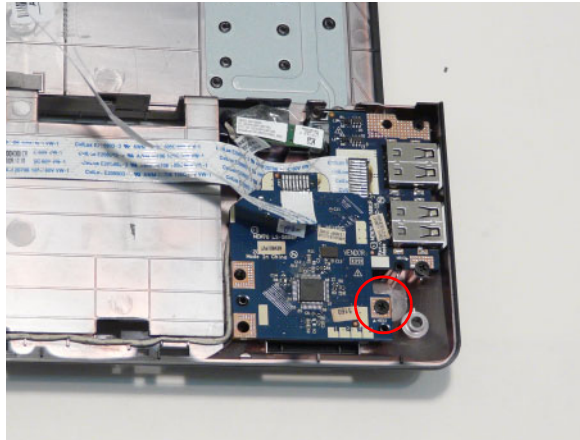

3. Connect the card reader cable and lock the connector.

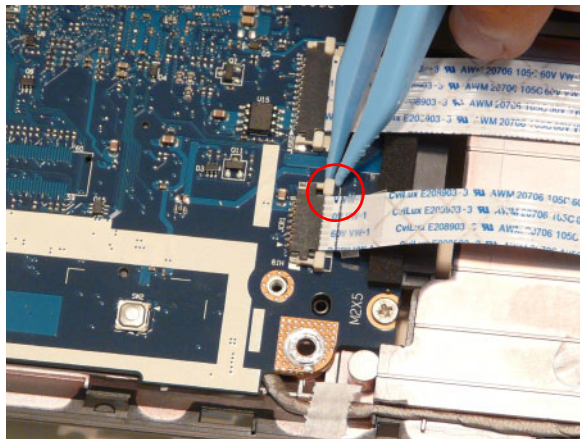

Replacing the TouchPad Bracket

1. Replace the TouchPad bracket top edge first to engage the securing clips and press down firmly.

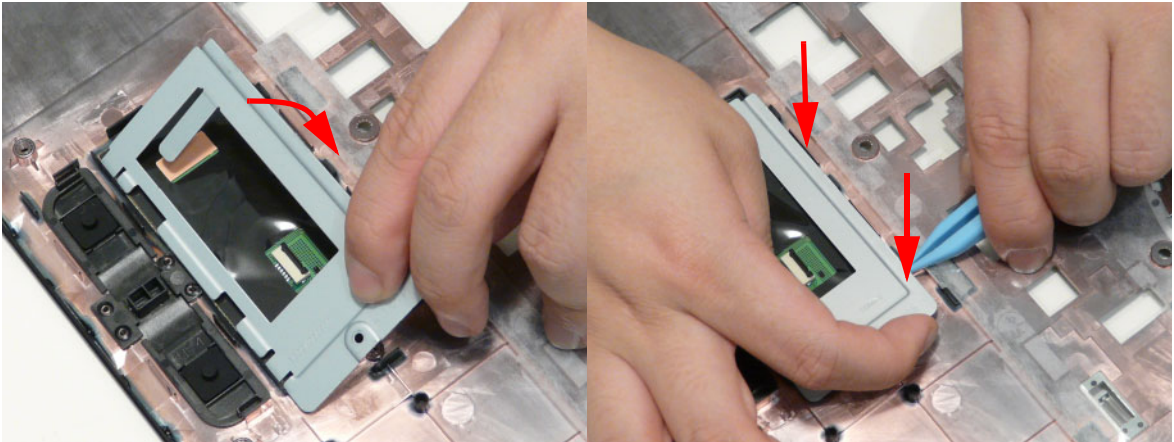

2. Replace the one (1) screw to secure the TouchPad Bracket to the Upper Cover.

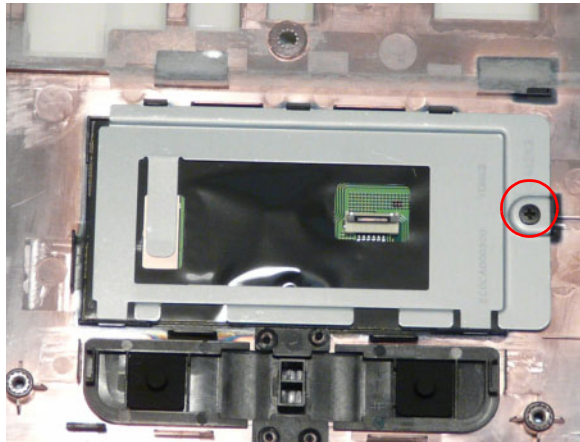

3. Replace the TouchPad FFC and close the locking latch on the connector.

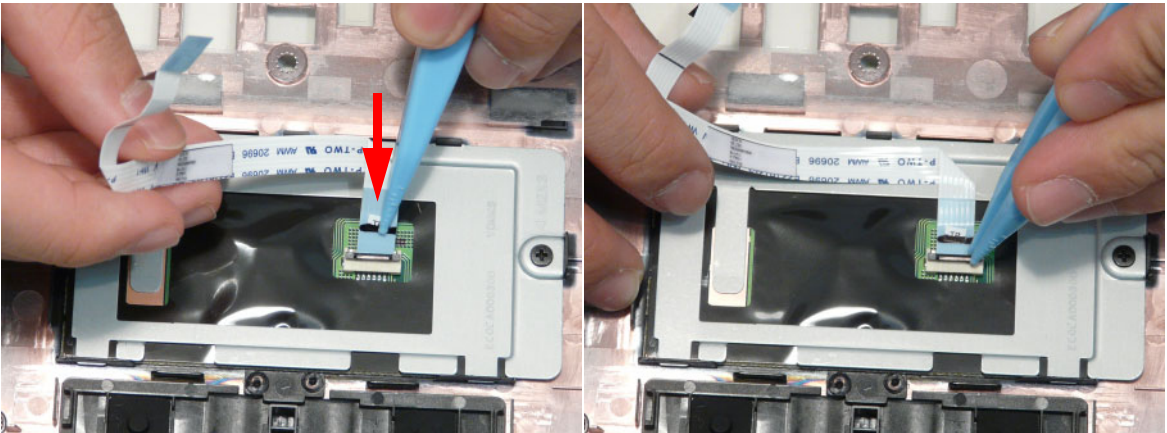

4. Replace the FFC and press down as indicated to secure it to the Upper Cover.

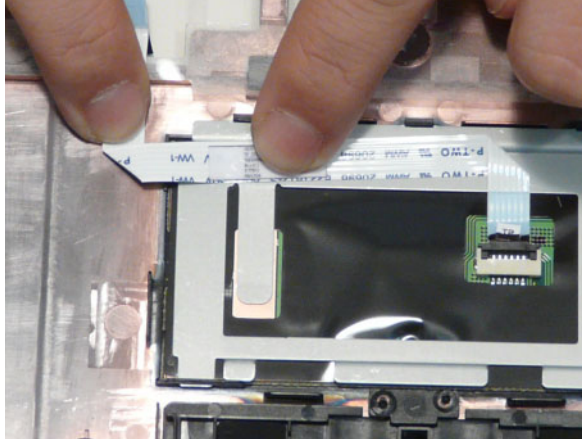

Replacing the Power Board

1. Place the power board in the chassis. Adhere the power board assembly as shown.

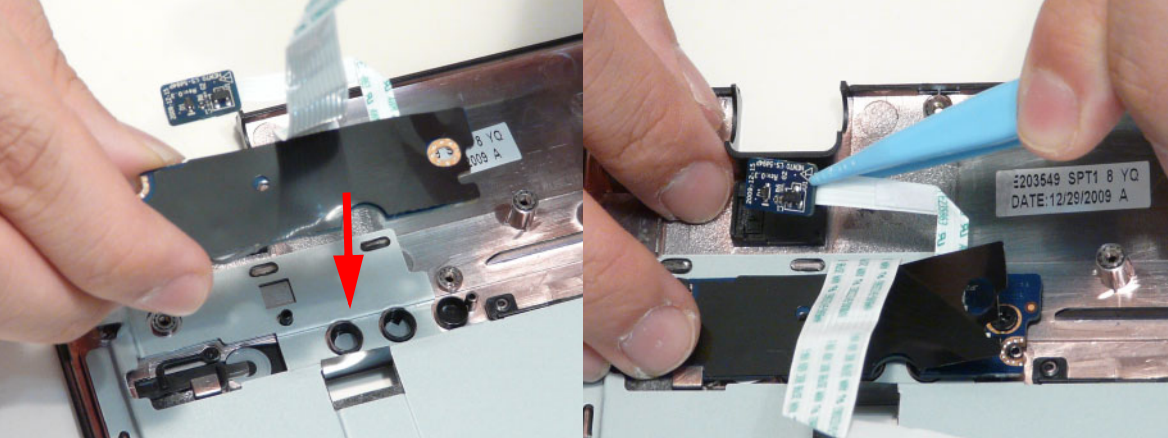

2. Secure two (2) screws on the power board.

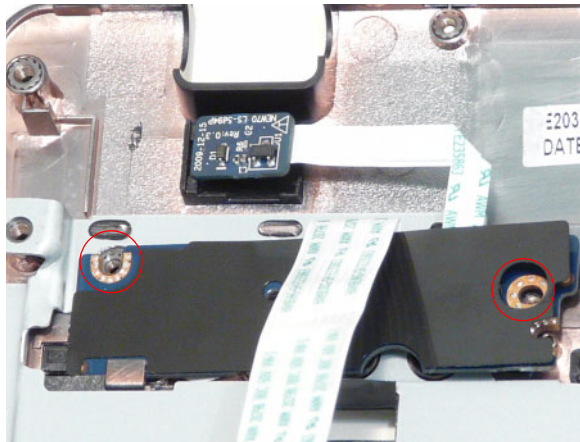

3. Pass the power board cable through the upper cover. Adhere the power board cable as shown.



Replacing the Right Speaker Module

1. Place the right speaker module in the chassis as shown.

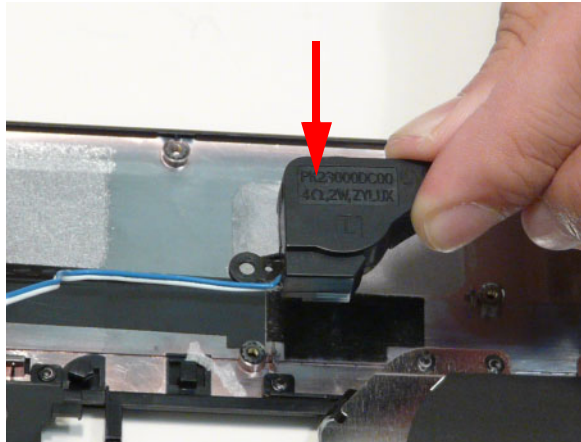

2. Run the speaker cable along the channel.

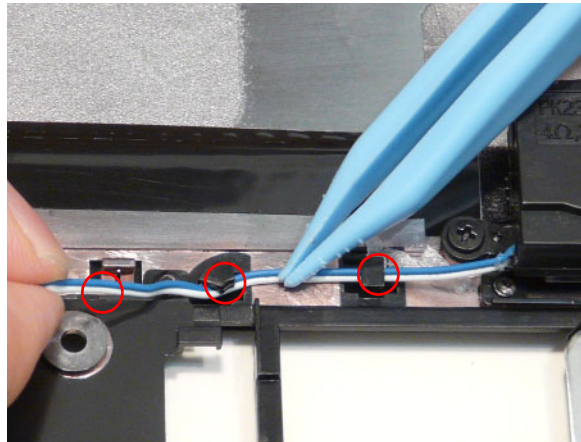

3. Secure the one (1) securing screw on the Right Speaker Module.

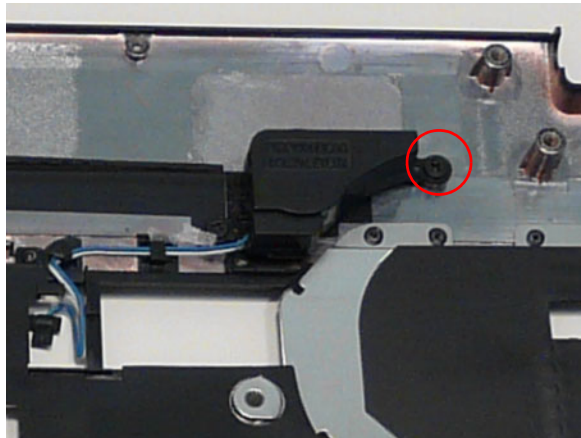

Replacing the Left Speaker Module

1. Place the module right side first on the Upper Cover as shown.
2. Run the Speaker cable along the cable channel.

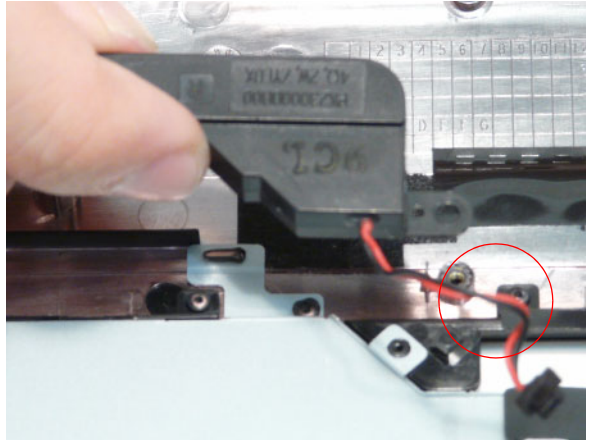
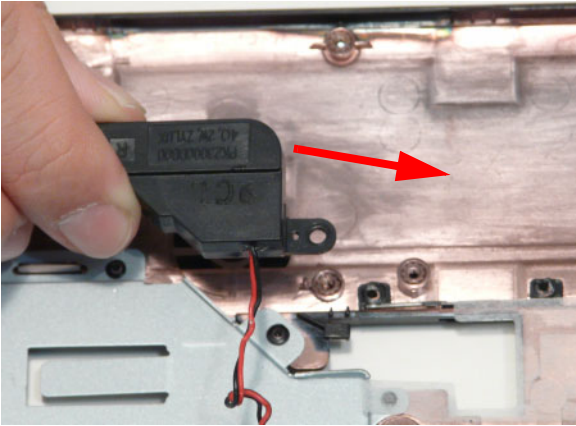

3. Secure two (2) screws from the left speaker module.

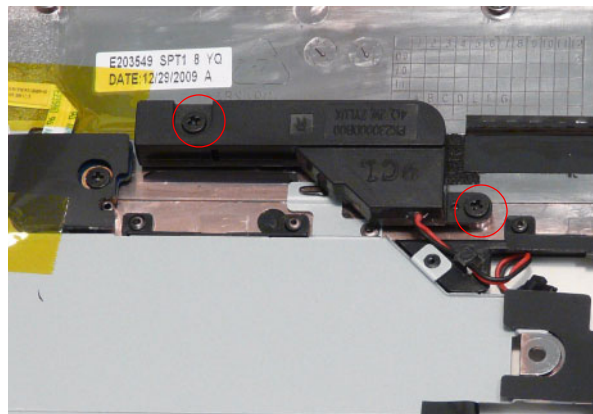

Replacing the Upper Cover

1. Place the Upper Cover on the Lower Cover as shown.

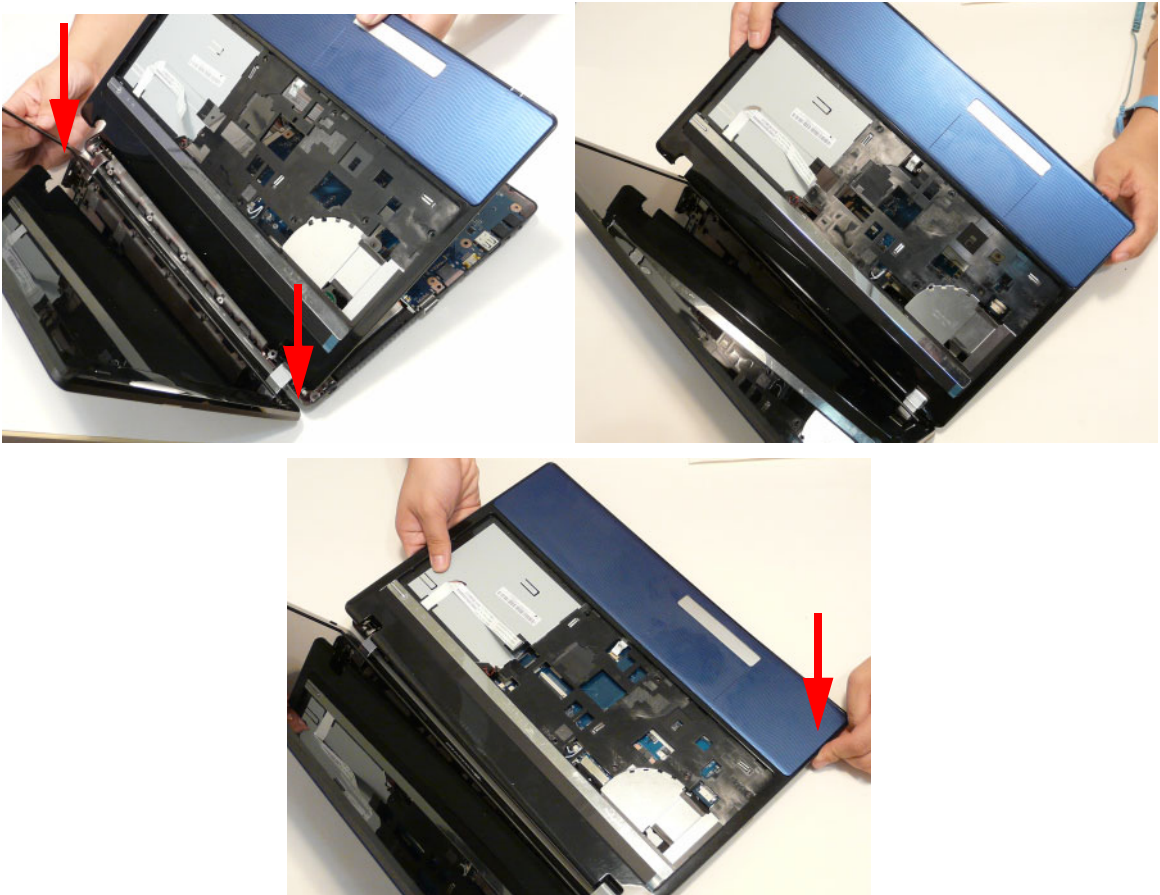

2. Secure the seven (7) screws on the Upper Cover as shown.

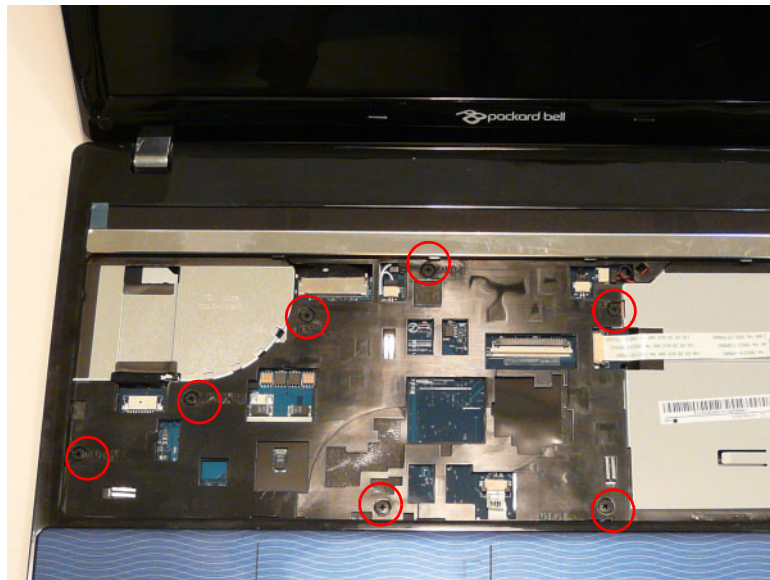

3. Connect the following cables to the Mainboard.

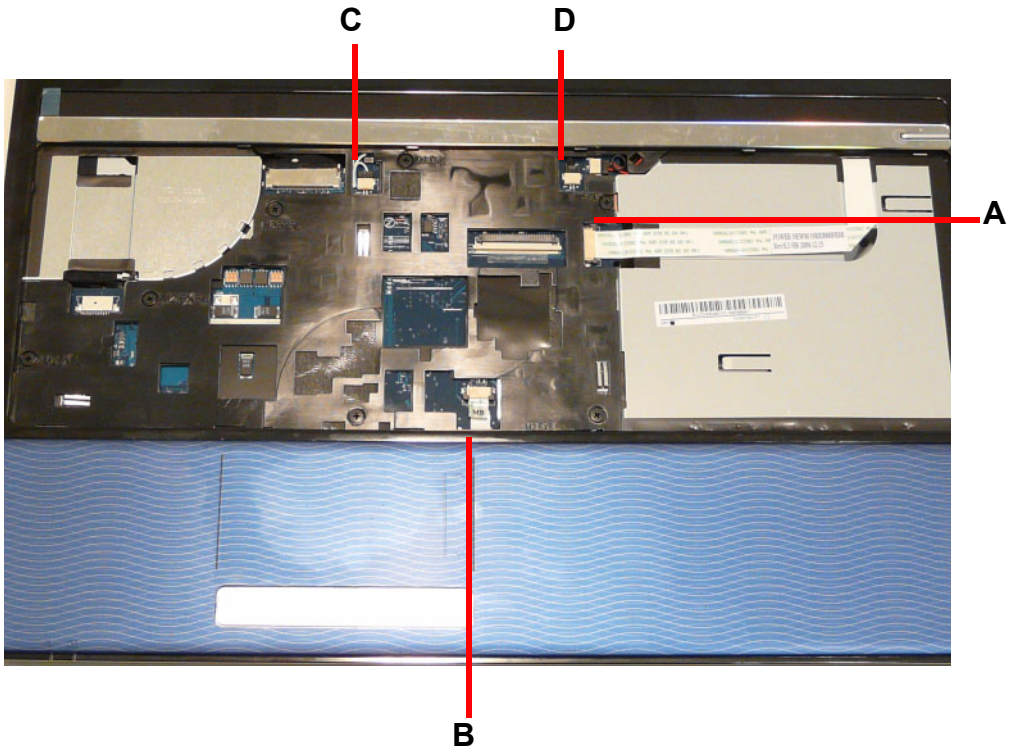

4. Connect **D** as shown.

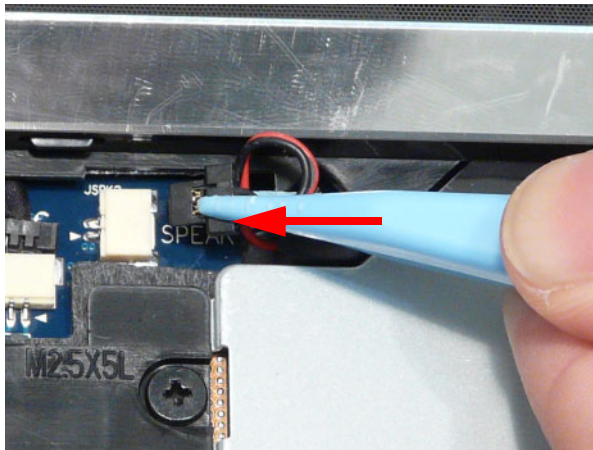

5. Connect **C** as shown.

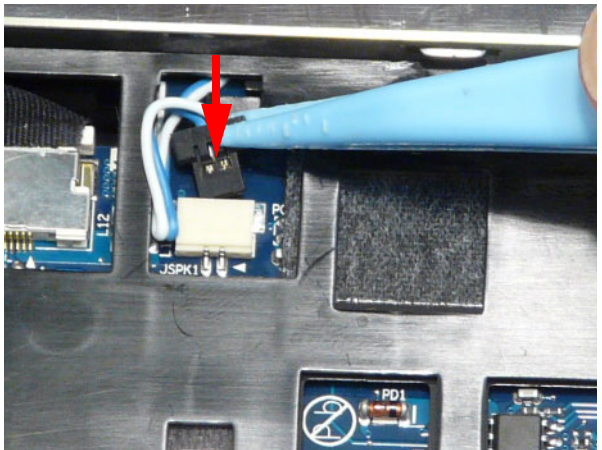

6. Connect **B** as shown.

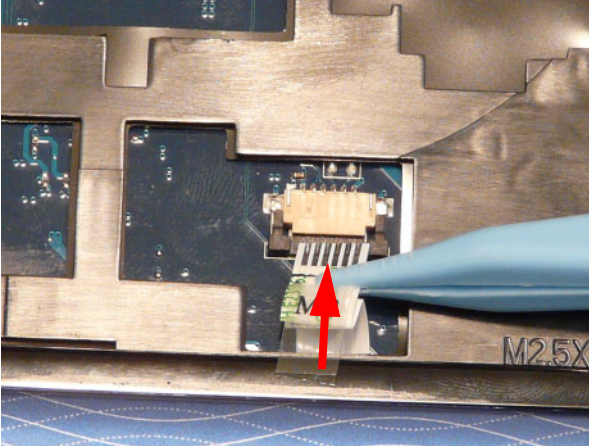

7. Connect **A** as shown.

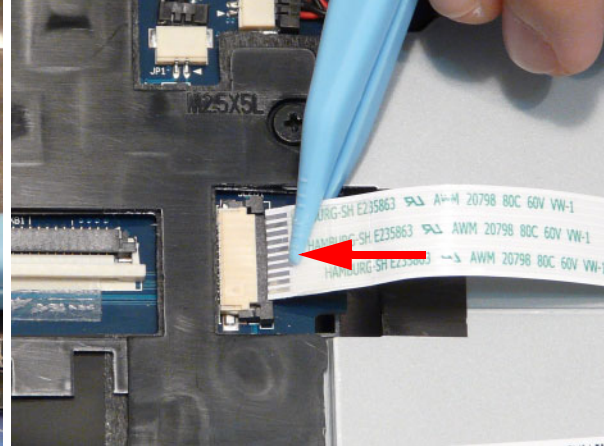

8. Turn the computer over. Replace the eleven (11) screws on the lower cover and five (5) screws from the battery bay.

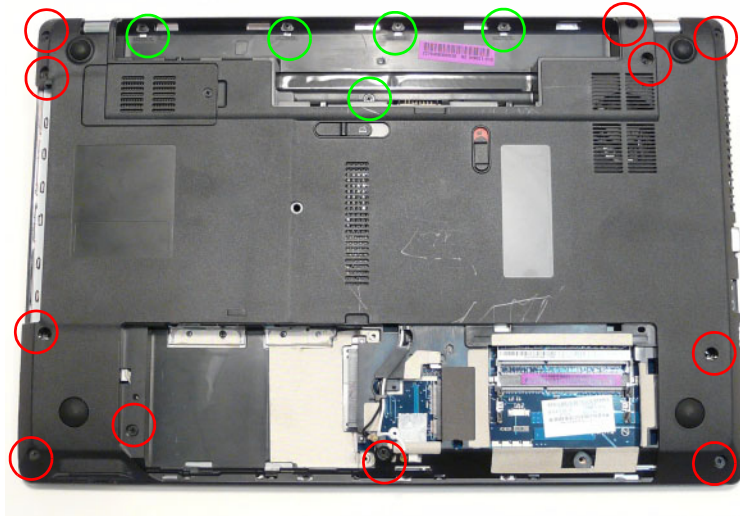

Replacing the Keyboard

1. Connect the Keyboard FFC to the Mainboard and close the locking latch to secure the cable in place.

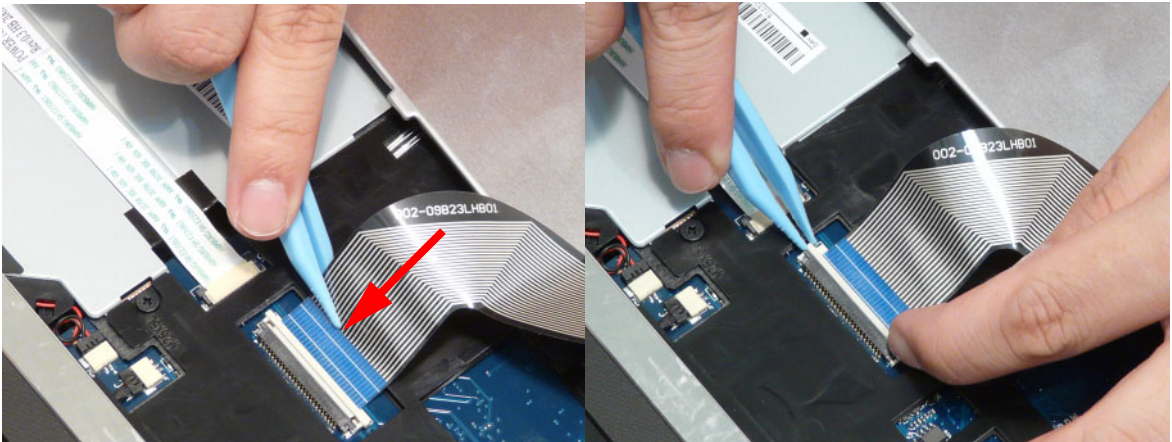

2. Replace the Keyboard by first lining up the bottom edge. Press down firmly to lock.



Replacing the Hard Disk Drive Module

1. Place the HDD in the HDD carrier.
2. Replace the four (4) screws (two each side) to secure the carrier.

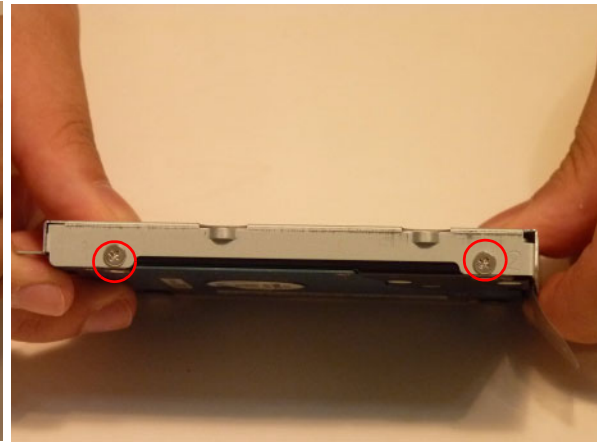
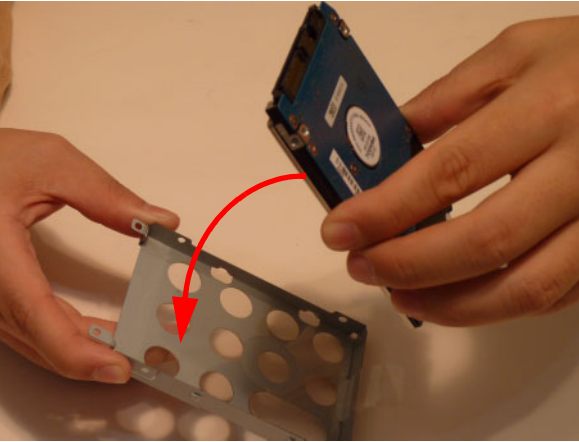

3. Insert the HDD, as indicated and lower it into place.
4. Slide the HDD in the direction of the arrow to connect the interface.

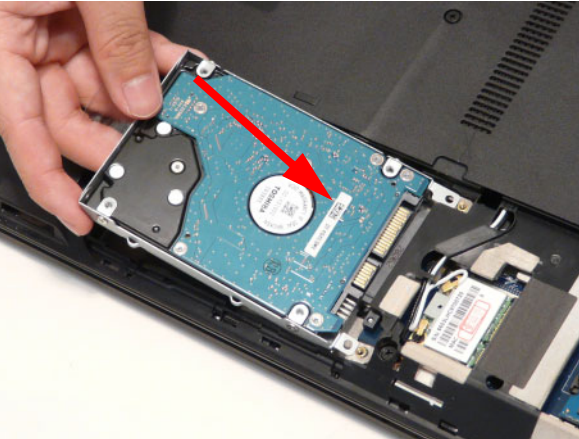

Replacing the WLAN Module

1. Insert the WLAN Module into the WLAN socket.
2. Replace the one (1) screw to secure the module.

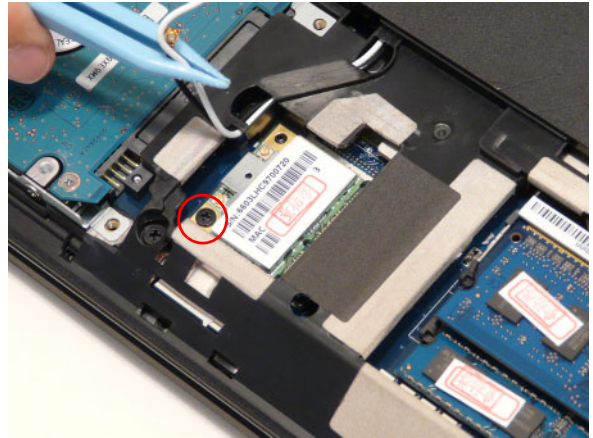
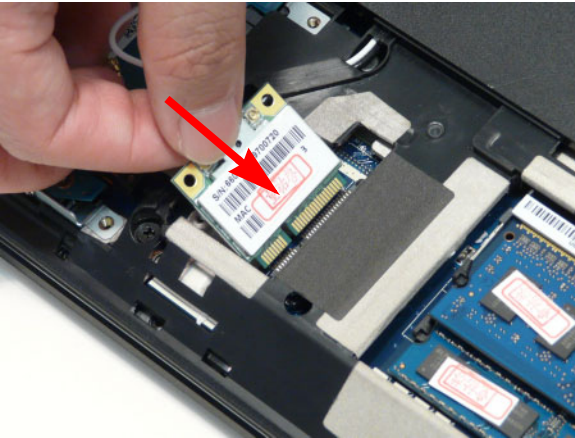

3. Connect the two (2) Antenna cables to the module.

NOTE: The black cable connects to the upper terminal (MAIN) and the white cable to the lower terminal (MAIN).

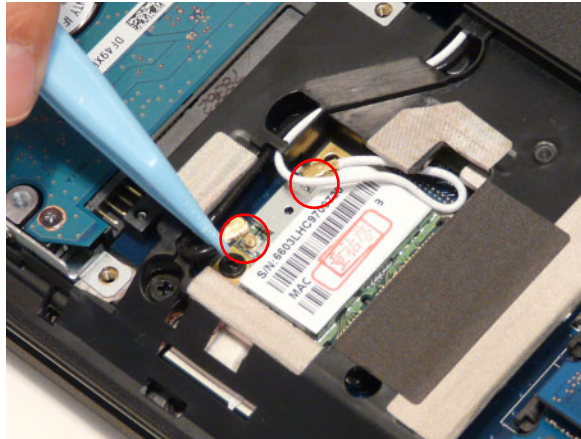

Replacing the DIMM Modules

1. Insert the DIMM Module in place.



2. Press down to lock the DIMM module in place.

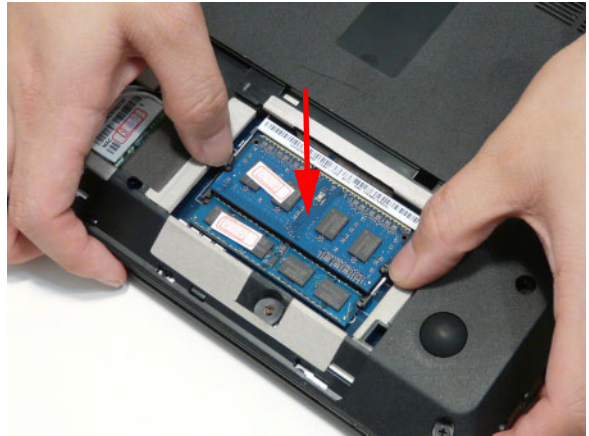

3. Repeat steps for the second DIMM module if present.

Replacing the 3G Module

1. Insert the 3G card into the slot.



2. Replace one (1) screw from the 3G module.



3. Connect two (2) antenna cables.



4. Line up the right edge of the 3G cover and replace.



5. Secure one (1) screw on the 3G Cover.



Replacing the Logic Lower Door

1. Replace the door by first lining up the top edge as shown.



2. Secure three (3) screws on the lower cover.

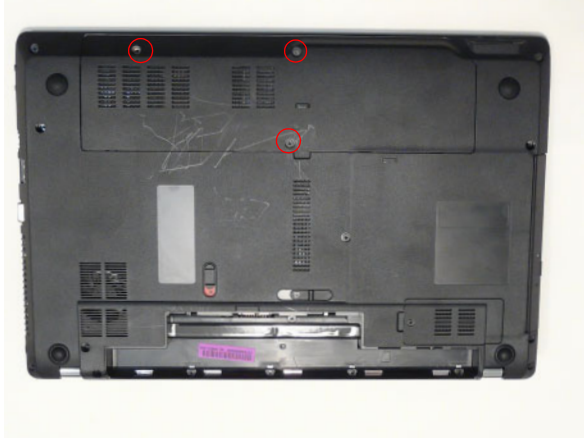

Replacing the ODD Module

1. Press the bezel into the tray, bottom edge first, to secure it to the ODD Module.
2. Place the bracket on the ODD module.



3. Secure the ODD bracket with the two (2) screws.

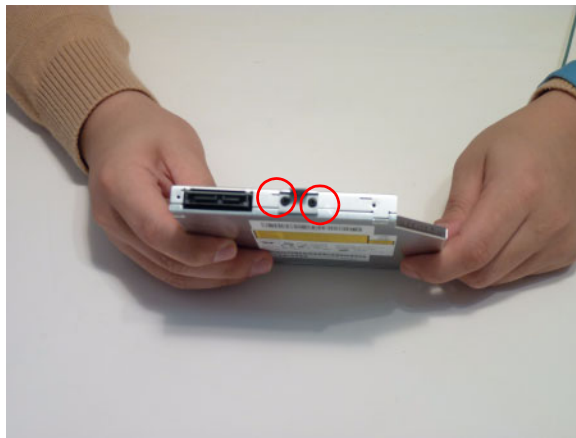

4. Push the ODD Module into the ODD bay until it is flush with the casing.
5. Replace the one (1) screw to secure the Module.

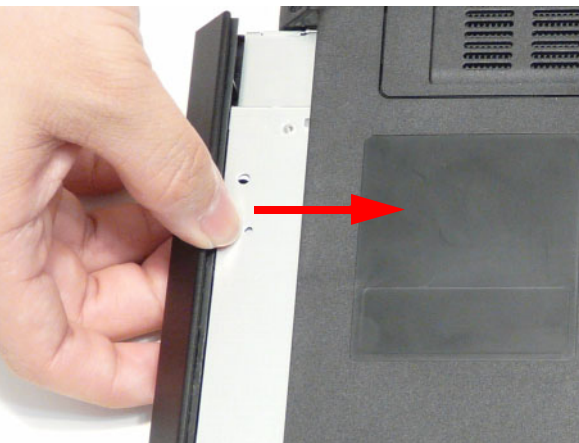

Replacing the SD Dummy Card

1. Insert the SD Dummy Card into the slot as shown.
2. Push until the card clicks into place and is flush with the casing.



Replacing the SIM Card

1. Insert the SIM Card into the slot as shown.
2. Push until the card clicks into place and is flush with the casing.

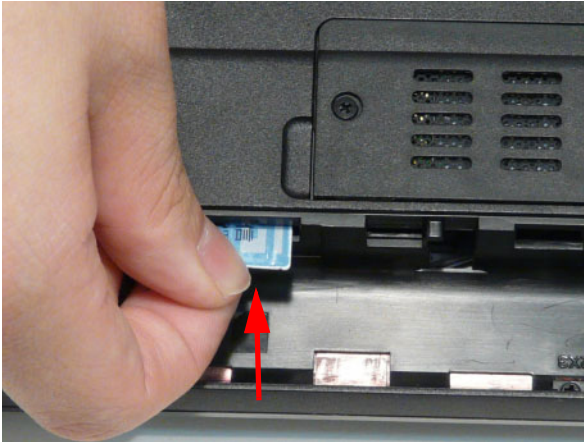

Replacing the Battery

1. Slide and hold the battery release latch to the release position (1), insert the battery pack and press down (2).



2. Slide the battery lock in the direction shown to secure the battery in place.



Troubleshooting

Common Problems

Use the following procedure as a guide for computer problems.

NOTE: The diagnostic tests are intended to test only Acer products. Non-Acer products, prototype cards, or modified options can give false errors and invalid system responses.

1. Obtain the failing symptoms in as much detail as possible.
2. Verify the symptoms by attempting to re-create the failure by running the diagnostic test or by repeating the same operation.
3. Use the following table with the verified symptom to determine which page to go to.

Symptoms (Verified)	Go To
Power On Issue	Page 140
No Display Issue	Page 141
LCD Failure	Page 143
Internal Keyboard Failure	Page 143
TouchPad Failure	Page 144
Internal Speaker Failure	Page 144
ODD Failure	Page 147
WLAN Failure	Page 150
Thermal Unit Failure	Page 150
Other Functions Failure	Page 151
Intermittent Failures	Page 152
Undermined Failures	Page 152

4. If the Issue is still not resolved, see “Online Support Information” on page 201.

Power On Issue

If the system doesn't power on, perform the following actions one at a time to correct the problem. Do not replace a non-defective FRUs:

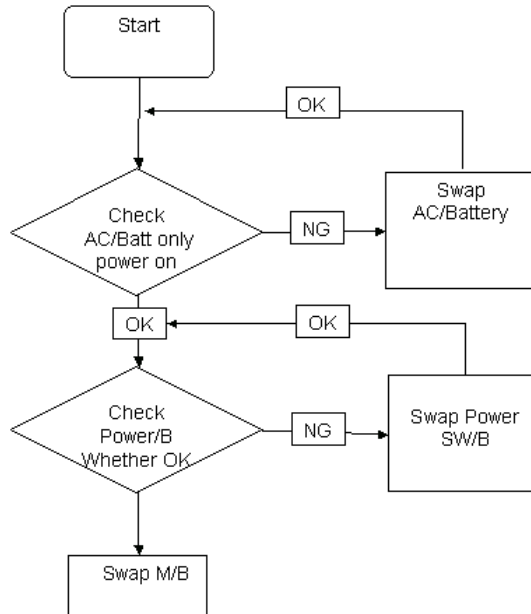

Computer Shutdown Intermittently

If the system powers off at intervals, perform the following actions one at a time to correct the problem.

1. Check the power cable is properly connected to the computer and the electrical outlet.
2. Remove any extension cables between the computer and the outlet.
3. Remove any surge protectors between the computer and the electrical outlet. Plug the computer directly into a known good electrical outlet.
4. Disconnect the power and open the casing to check the Thermal Unit (see "Thermal Unit Failure" on page 150) and fan airways are free of obstructions.
5. Remove all external and non-essential hardware connected to the computer that are not necessary to boot the computer to the failure point.
6. Remove any recently installed software.
7. If the Issue is still not resolved, see "Online Support Information" on page 201.

No Display Issue

If the **Display** doesn't work, perform the following actions one at a time to correct the problem. Do not replace a non-defective FRUs:

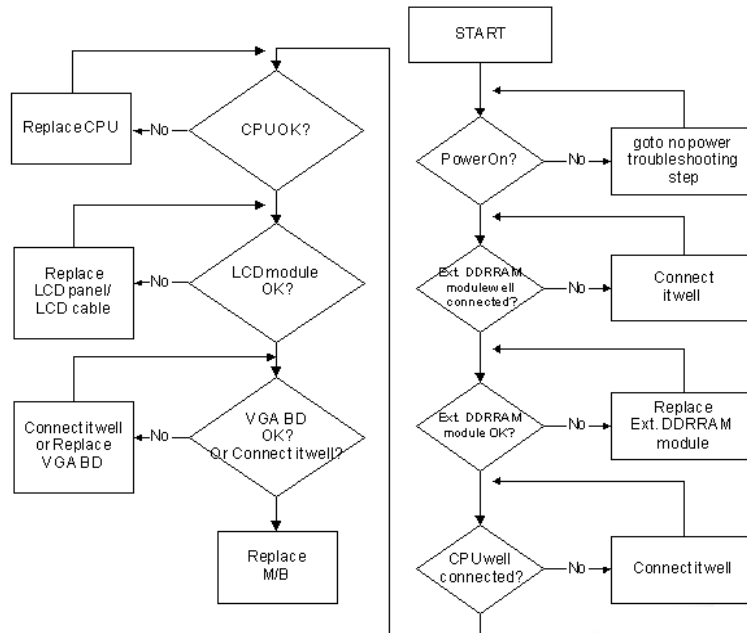

No POST or Video

If the POST or video doesn't display, perform the following actions one at a time to correct the problem.

1. Make sure that the internal display is selected. On this notebook model, switching between the internal display and the external display is done by pressing **Fn+F5**. Reference Product pages for specific model procedures.
2. Make sure the computer has power by checking at least one of the following occurs:
 - Fans start up
 - Status LEDs light up

If there is no power, see "Power On Issue" on page 140.

3. Drain any stored power by removing the power cable and battery and holding down the power button for 10 seconds. Reconnect the power and reboot the computer.
4. Connect an external monitor to the computer and switch between the internal display and the external display is by pressing **Fn+F5** (on this model).

If the POST or video appears on the external display, see "LCD Failure" on page 143.

5. Disconnect power and all external devices including port replicators or docking stations. Remove any memory cards and CD/DVD discs. Restart the computer.

If the computer boots correctly, add the devices one by one until the failure point is discovered.

6. Reseat the memory modules.
7. Remove the drives (see "Disassembly Process" on page 43).
8. If the Issue is still not resolved, see "Online Support Information" on page 201.

Abnormal Video Display

If video displays abnormally, perform the following actions one at a time to correct the problem.

1. Reboot the computer.
2. If permanent vertical/horizontal lines or dark spots display in the same location, the LCD is faulty and should be replaced. See “Disassembly Process” on page 43.
3. If extensive pixel damage is present (different colored spots in the same locations on the screen), the LCD is faulty and should be replaced. See “Disassembly Process” on page 43.
4. Adjust the brightness to its highest level. See the User Manual for instructions on adjusting settings.
NOTE: Ensure that the computer is not running on battery alone as this may reduce display brightness.
If the display is too dim at the highest brightness setting, the LCD is faulty and should be replaced. See “Disassembly Process” on page 43.
5. Check the display resolution is correctly configured:
 - a. Minimize or close all Windows.
 - b. If display size is only abnormal in an application, check the view settings and control/mouse wheel zoom feature in the application.
 - c. If desktop display resolution is not normal, right-click on the desktop and select **Personalize**→ **Display Settings**.
 - d. Click and drag the Resolution slider to the desired resolution.
 - e. Click **Apply** and check the display. Readjust if necessary.
6. Roll back the video driver to the previous version if updated.
7. Remove and reinstall the video driver.
8. Check the Device Manager to determine that:
 - The device is properly installed. There are no red Xs or yellow exclamation marks.
 - There are no device conflicts.
 - No hardware is listed under Other Devices.
9. If the Issue is still not resolved, see “Online Support Information” on page 201.
10. Run the Windows Memory Diagnostic from the operating system DVD and follow the onscreen prompts.
11. If the Issue is still not resolved, see “Online Support Information” on page 201.

Random Loss of BIOS Settings

If the computer is experiencing intermittent loss of BIOS information, perform the following actions one at a time to correct the problem.

1. If the computer is more than one year old, replace the CMOS battery.
2. Run a complete virus scan using up-to-date software to ensure the computer is virus free.
3. If the computer is experiencing HDD or ODD BIOS information loss, disconnect and reconnect the power and data cables between devices.
If the BIOS settings are still lost, replace the cables.
4. If HDD information is missing from the BIOS, the drive may be defective and should be replaced.
5. Replace the Motherboard.
6. If the Issue is still not resolved, see “Online Support Information” on page 201.

LCD Failure

If the **LCD** fails, perform the following actions one at a time to correct the problem. Do not replace a non-defective FRUs:

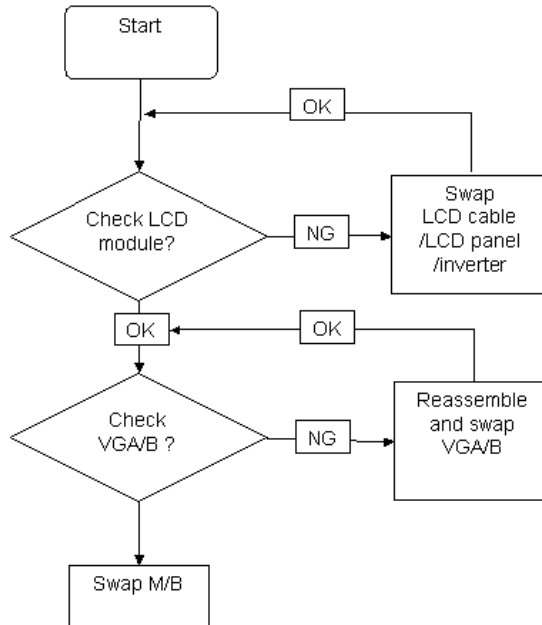

Built-In Keyboard Failure

If the built-in **Keyboard** fails, perform the following actions one at a time to correct the problem. Do not replace a non-defective FRUs:

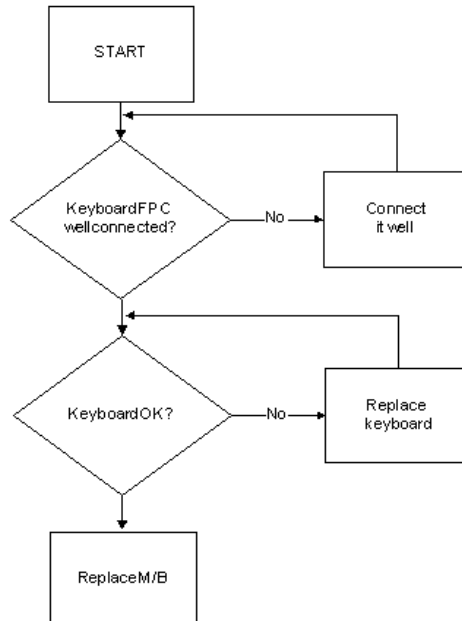

TouchPad Failure

If the **TouchPad** doesn't work, perform the following actions one at a time to correct the problem. Do not replace a non-defective FRUs:

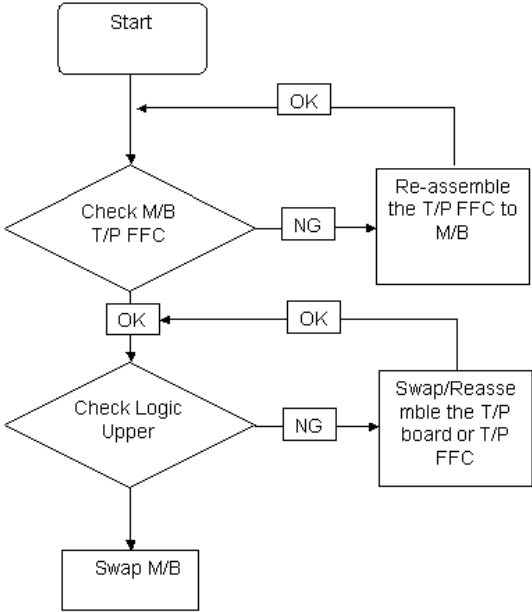

Internal Speaker Failure

If the internal **Speakers** fail, perform the following actions one at a time to correct the problem. Do not replace a non-defective FRUs:

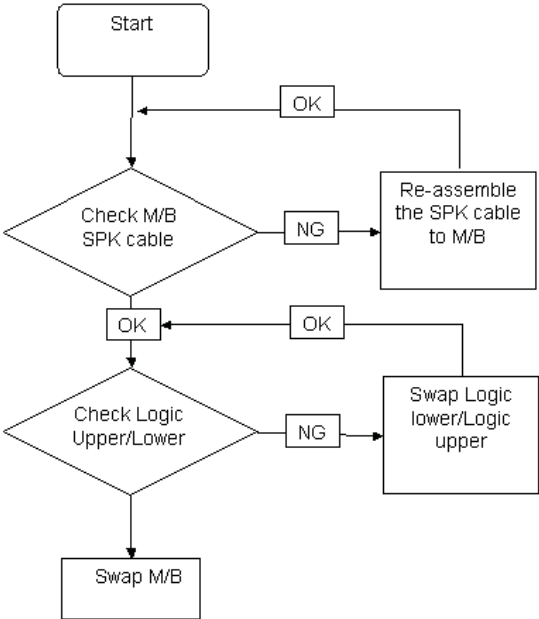

Sound Problems

If sound problems are experienced, perform the following actions one at a time to correct the problem.

1. Reboot the computer.
2. Navigate to **Start**→ **Control Panel**→ **System and Maintenance**→ **System**→ **Device Manager**. Check the Device Manager to determine that:
 - The device is properly installed.
 - There are no red Xs or yellow exclamation marks.
 - There are no device conflicts.
 - No hardware is listed under Other Devices.
3. Roll back the audio driver to the previous version, if updated recently.
4. Remove and reinstall the audio driver.
5. Ensure that all volume controls are set mid range:
 - a. Click the volume icon on the taskbar and drag the slider to 50. Ensure that the volume is not muted.
 - b. Click Mixer to verify that other audio applications are set to 50 and not muted.
6. Navigate to **Start**→ **Control Panel**→ **Hardware and Sound**→ **Sound**. Ensure that Speakers are selected as the default audio device (green check mark).

NOTE: If Speakers does not show, right-click on the **Playback** tab and select **Show Disabled Devices** (clear by default).
7. Select Speakers and click **Configure** to start **Speaker Setup**. Follow the onscreen prompts to configure the speakers.
8. Remove and recently installed hardware or software.
9. Restore system and file settings from a known good date using **System Restore**.

If the issue is not fixed, repeat the preceding steps and select an earlier time and date.
10. Reinstall the Operating System.
11. If the Issue is still not resolved, see “Online Support Information” on page 201.

Microphone Problems

If internal or external **Microphones** do not operate correctly, perform the following actions one at a time to correct the problem.

1. Check that the microphone is enabled. Navigate to **Start**→ **Control Panel**→ **Hardware and Sound**→ **Sound** and select the **Recording** tab.
2. Right-click on the **Recording** tab and select **Show Disabled Devices** (clear by default).
3. The microphone appears on the **Recording** tab.
4. Right-click on the microphone and select **Enable**.
5. Select the microphone then click **Properties**. Select the **Levels** tab.
6. Increase the volume to the maximum setting and click **OK**.
7. Test the microphone hardware:
 - a. Select the microphone and click **Configure**.
 - b. Select **Set up microphone**.
 - c. Select the microphone type from the list and click **Next**.
 - d. Follow the onscreen prompts to complete the test.
8. If the Issue is still not resolved, see “Online Support Information” on page 201.

HDD Not Operating Correctly

If the **HDD** does not operate correctly, perform the following actions one at a time to correct the problem.

1. Disconnect all external devices.
2. Run a complete virus scan using up-to-date software to ensure the computer is virus free.
3. Run the Windows 7 Startup Repair Utility:
 - a. insert the Windows 7 Operating System DVD in the ODD and restart the computer.
 - b. When prompted, press any key to start to the operating system DVD.
 - c. The **Install Windows** screen displays. Click **Next**.
 - d. Select **Repair your computer**.
 - e. The **System Recovery Options** screen displays. Click **Next**.
 - f. Select the appropriate operating system, and click **Next**.

NOTE: Click **Load Drivers** if controller drives are required.

- g. Select **Startup Repair**.
- h. Startup Repair attempts to locate and resolve issues with the computer.
- i. When complete, click **Finish**.

If an issue is discovered, follow the onscreen information to resolve the problem.

4. Run the Windows Memory Diagnostic Tool. For more information see Windows Help and Support.
5. Restart the computer and press F2 to enter the BIOS Utility. Check the BIOS settings are correct and that CD/DVD drive is set as the first boot device on the Boot menu.
6. Ensure all cables and jumpers on the HDD and ODD are set correctly.
7. Remove any recently added hardware and associated software.
8. Run the Windows Disk Defragmenter. For more information see Windows Help and Support.
9. Run Windows Check Disk by entering **chkdsk /r** from a command prompt. For more information see Windows Help and Support.
10. Restore system and file settings from a known good date using **System Restore**.

If the issue is not fixed, repeat the preceding steps and select an earlier time and date.
11. Replace the HDD. See "Disassembly Process" on page 43.

ODD Failure

If the **ODD** fails, perform the following actions one at a time to correct the problem. Do not replace a non-defective FRUs:

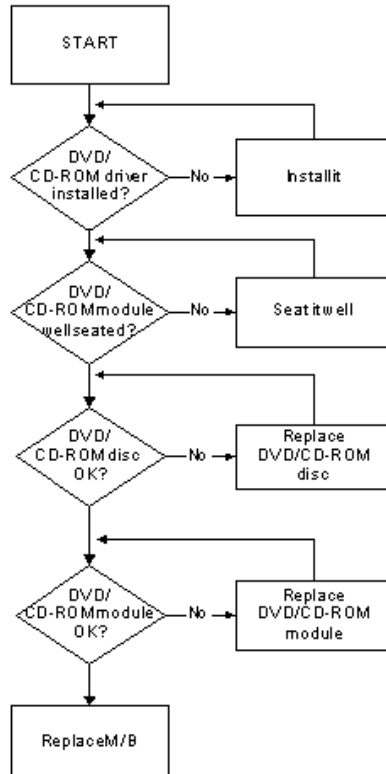

ODD Not Operating Correctly

If the **ODD** exhibits any of the following symptoms it may be faulty:

- Audio CDs do not play when loaded
- DVDs do not play when loaded
- Blank discs do not burn correctly
- DVD or CD play breaks up or jumps
- Optical drive not found or not active:
 - Not shown in My Computer or the BIOS setup
 - LED does not flash when the computer starts up
 - The tray does not eject
- Access failure screen displays
- The ODD is noisy

Perform the following general solutions one at a time to correct the problem.

1. Reboot the computer and retry the operation.
2. Try an alternate disc.
3. Navigate to **Start** → **Computer**. Check that the ODD device is displayed in the **Devices with Removable Storage** panel.
4. Navigate to **Start** → **Control Panel** → **System and Maintenance** → **System** → **Device Manager**.

-
- a. Double-click **IDE ATA/ATAPI controllers**. If a device displays a down arrow, right-click on the device and click **Enable**.
 - b. Double-click **DVD/CD-ROM drives**. If the device displays a down arrow, right-click on the device and click **Enable**.
 - c. Check that there are no yellow exclamation marks against the items in **IDE ATA/ATAPI controllers**. If a device has an exclamation mark, right-click on the device and uninstall and reinstall the driver.
 - d. Check that there are no yellow exclamation marks against the items in **DVD/CD-ROM drives**. If a device has an exclamation mark, right-click on the device and uninstall and reinstall the driver.
 - e. If the exclamation marker is not removed from the item in the lists, try removing any recently installed software and retrying the operation.

Discs Do Not Play

If discs do not play when inserted in the drive, perform the following actions one at a time to correct the problem.

1. Check that the disc is correctly seated in the drive tray and that the label on the disc is visible.
2. Check that the media is clean and scratch free.
3. Try an alternate disc in the drive.
4. Ensure that **AutoPlay** is enabled:
 - a. Navigate to **Start** → **Control Panel** → **Hardware and Sound** → **AutoPlay**.
 - b. Select **Use AutoPlay for all media and devices**.
 - c. In the Audio CD and DVD Movie fields, select the desired player from the drop down menu.
5. Check that the Regional Code is correct for the selected media:

IMPORTANT:Region can only be changed a limited number of times. After Changes remaining reaches zero, the region cannot be changed even Windows is reinstalled or the drive is moved to another computer.

- a. Navigate to **Start** → **Control Panel** → **System and Maintenance** → **System** → **Device Manager**.
- b. Double-click **DVD/CD-ROM drives**.
- c. Right-click **DVD drive** and click **Properties**, then click the **DVD Region** tab.
- d. Select the region suitable for the media inserted in the drive.

Discs Do Not Burn Properly

If discs can not be burned, perform the following actions one at a time to correct the problem.

1. Ensure that the default drive is record enabled:
 - a. Navigate to **Start** → **Computer** and right-click the writable ODD icon. Click **Properties**.
 - b. Select the **Recording** tab. In the **Desktop disc recording** panel, select the writable ODD from the drop down list.
 - c. Click **OK**.
2. Ensure that the software used for burning discs is the factory default. If using different software, refer to the software's user manual.

Playback is Choppy

If playback is choppy or jumps, perform the following actions one at a time to correct the problem.

1. Check that system resources are not running low:
 - a. Try closing some applications.
 - b. Reboot and try the operation again.
2. Check that the ODD controller transfer mode is set to DMA:
 - a. Navigate to **Start** → **Control Panel** → **System and Maintenance** → **System** → **Device Manager**.

-
- b. Double-click **IDE ATA/ATAPI controllers**, then right-click ATA Device 0.
 - c. Click **Properties** and select the **Advanced Settings** tab. Ensure that the **Enable DMA** box is checked and click **OK**.
 - d. Repeat for the other ATA Devices shown if applicable.

Drive Not Detected

If Windows cannot detect the drive, perform the following actions one at a time to correct the problem.

1. Restart the computer and press F2 to enter the BIOS Utility.
2. Check that the drive is detected in the **ATAPI Model Name** field on the Information page.
NOTE: Check that the entry is identical to one of the ODDs specified in “Hardware Specifications and Configurations” on page 16.
3. Turn off the power and remove the cover to inspect the connections to the ODD. See “Disassembly Process” on page 43.
 - a. Check for broken connectors on the drive, motherboard, and cables.
 - b. Check for bent or broken pins on the drive, motherboard, and cable connections.
 - c. Try an alternate cable, if available. If the drive works with the new cable, the original cable should be replaced.
4. Reseat the drive ensuring and all cables are connected correctly.
5. Replace the ODD. See “Disassembly Process” on page 43.

Drive Read Failure

If discs cannot be read when inserted in the drive, perform the following actions one at a time to correct the problem.

1. Remove and clean the failed disc.
2. Retry reading the CD or DVD.
 - d. Test the drive using other discs.
 - e. Play a DVD movie
 - f. Listen to a music CD

If the ODD works properly with alternate discs, the original disc is probably defective and should be replaced.

3. Turn off the power and remove the cover to inspect the connections to the ODD. See “Disassembly Process” on page 43.
 - a. Check for broken connectors on the drive, motherboard, and cables.
 - b. Check for bent or broken pins on the drive, motherboard, and cable connections.
 - c. Try an alternate cable, if available. If the drive works with the new cable, the original cable should be replaced.
4. Replace the ODD. See “Disassembly Process” on page 43.

Wireless Function Failure

If the **WLAN** fails, perform the following actions one at a time to correct the problem. Do not replace a non-defective FRUs:

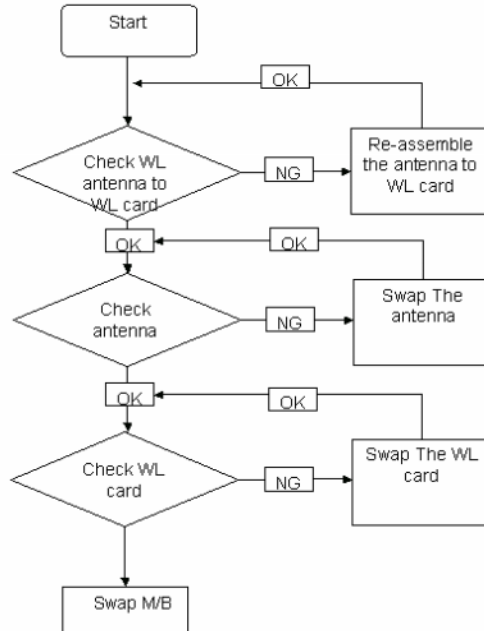

Thermal Unit Failure

If the **Thermal Unit** fails, perform the following actions one at a time to correct the problem. Do not replace a non-defective FRUs:

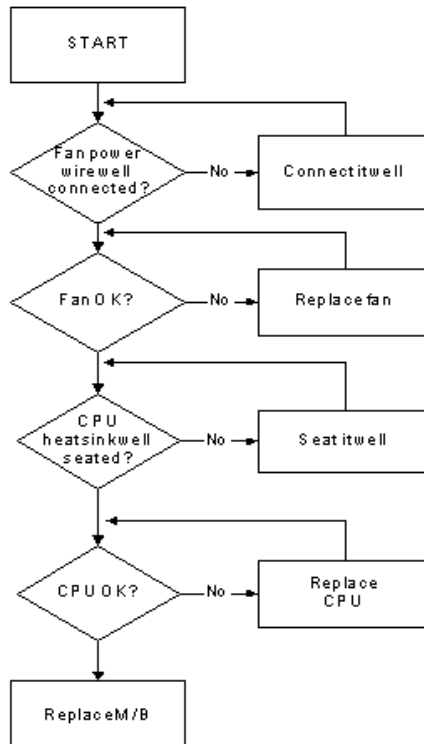

External Mouse Failure

If an external **Mouse** fails, perform the following actions one at a time to correct the problem.

1. Try an alternative mouse.
2. If the mouse uses a wireless connection, insert new batteries and confirm there is a good connection. See the mouse user manual.
3. If the mouse uses a USB connection, try an alternate USB port.
4. Try an alternative program to verify mouse operation. Reinstall the program experiencing mouse failure.
5. Restart the computer.
6. Remove any recently added hardware and associated software.
7. Remove any recently added software and reboot.
8. Restore system and file settings from a known good date using **System Restore**.
If the issue is not fixed, repeat the preceding steps and select an earlier time and date.
9. Run the Event Viewer to check the events log for errors. For more information see Windows Help and Support.
10. Roll back the mouse driver to the previous version if updated recently.
11. Remove and reinstall the mouse driver.
12. Check the Device Manager to determine that:
 - The device is properly installed. There are no red Xs or yellow exclamation marks.
 - There are no device conflicts.
 - No hardware is listed under Other Devices.
13. If the Issue is still not resolved, see “Online Support Information” on page 201.

Other Failures

If the CRT Switch, Dock, LAN Port, external MIC or Speakers, PCI Express Card, 5-in-1 Card Reader or Volume Wheel fail, perform the following general steps to correct the problem. Do not replace a non-defective FRUs:

1. Check Drive whether is OK.
2. Check Test Fixture is ok.
3. Swap M/B to Try.

Intermittent Problems

Intermittent system hang problems can be caused by a variety of reasons that have nothing to do with a hardware defect, such as: cosmic radiation, electrostatic discharge, or software errors. FRU replacement should be considered only when a recurring problem exists.

When analyzing an intermittent problem, do the following:

1. Run the advanced diagnostic test for the system board in loop mode at least 10 times.
2. If no error is detected, do not replace any FRU.
3. If any error is detected, replace the FRU. Rerun the test to verify that there are no more errors.

Undetermined Problems

The diagnostic problems does not identify which adapter or device failed, which installed devices are incorrect, whether a short circuit is suspected, or whether the system is inoperative.

Follow these procedures to isolate the failing FRU (do not isolate non-defective FRU).

NOTE: Verify that all attached devices are supported by the computer.

NOTE: Verify that the power supply being used at the time of the failure is operating correctly. (See “Power On Issue” on page 140.):

1. Power-off the computer.
2. Visually check them for damage. If any problems are found, replace the FRU.
3. Remove or disconnect all of the following devices:
 - Non-Acer devices
 - Printer, mouse, and other external devices
 - Battery acp
 - Hard disk drive
 - DIMM
 - CD-ROM/Diskette drive Module
 - PC Cards
4. Power-on the computer.
5. Determine if the problem has changed.
6. If the problem does not recur, reconnect the removed devices one at a time until you find the failing FRU.
7. If the problem remains, replace the following FRU one at a time. Do not replace a non-defective FRU:
 - System board
 - LCD assembly

Post Codes

These tables describe the POST codes and descriptions during the POST.

Post Code Range

Phase	POST Code Range
SEC	0x01 - 0x0F
PEI	0x70 - 0x9F
DXE	0x40 - 0x6F
BDS	0x10 - 0x3F
SMM	0xA0 - 0xBF
S3	0xC0 - 0xCF
ASL	0x51 – 0x55
	0xE1 – 0xE4
PostBDS	0xF9 – 0xFE
InsydeH2ODDT™ Reserve	0xD0 – 0xD7
OEM Reserve	0xE8 – 0xEB
Reserved	0xD8 – 0xE0
	0xE5 – 0xE7
	0xEC – 0xF8

SEC Phase POST Code Table

Functionality Name (Include PostCode.h)	Phase	Post Code	Description
SEC_SYSTEM_POWER_ON	SEC	1	CPU power on and switch to Protected mode
SEC_BEFORE_MICROCODE_PATCH	SEC	2	Patching CPU microcode
SEC_AFTER_MICROCODE_PATCH	SEC	3	Setup Cache as RAM
SEC_ACCESS_CSR	SEC	4	PCIE MMIO Base Address initial
SEC_GENERIC_MSRRINIT	SEC	5	CPU Generic MSR initialization
SEC_CPU_SPEEDCFG	SEC	6	Setup CPU speed
SEC_SETUP_CAR_OK	SEC	7	Cache as RAM test
SEC_FORCE_MAX_RATIO	SEC	8	Tune CPU frequency ratio to maximum level
SEC_GO_TO_SECSTARTUP	SEC	9	Setup BIOS ROM cache
SEC_GO_TO_PEICORE	SEC	0A	Enter Boot Firmware Volume

NOTE: The color bar items indicate 3rd party related functions that are platform dependent.

PEI Phase POST Code Table:

Functionality Name (Include PostCode.h)	Phase	Post Code	Description
PEI_SIO_INIT	PEI	70	Super I/O Initialization
PEI_CPU_REG_INIT	PEI	71	CPU Early Initialization
PEI_CPU_AP_INIT	PEI	72	Multi-processor Early Initial
PEI_CPU_HT_RESET	PEI	73	HyperTransport Initialization
PEI_PCIE_MMIO_INIT	PEI	74	PCIE MMIO BAR Initialization
PEI_NB_REG_INIT	PEI	75	North Bridge Early Initialization
PEI_SB_REG_INIT	PEI	76	South Bridge Early Initialization
PEI_PCIE_TRAINING	PEI	77	PCIE Training
PEI_TPM_INIT	PEI	78	TPM Initialization
PEI_SMBUS_INIT	PEI	79	SMBUS Early Initialization
PEI_PROGRAM_CLOCK_GEN	PEI	7A	Clock Generator Initialization
PEI_IGD_EARLY_INITIAL	PEI	7B	Internal Graphic device early Initialization
PEI_HECI_INIT	PEI	7C	HECI Initialization
PEI_WATCHDOG_INIT	PEI	7D	Watchdog timer Initialization
PEI_MEMORY_INIT	PEI	7E	Memory Initial for Normal boot.
PEI_MEMORY_INIT_FOR_CRISIS	PEI	7F	Memory Initial for Crisis Recovery
PEI_MEMORY_INSTALL	PEI	80	Simple Memory test
PEI_TXTPEI	PEI	81	TXT function early Initialization
PEI_SWITCH_STACK	PEI	82	Start to use Memory
PEI_MEMORY_CALLBACK	PEI	83	Set cache for physical memory
PEI_ENTER_RECOVERY_MODE	PEI	84	Recovery device Initialization
PEI_RECOVERY_MEDIA_FOUND	PEI	85	Found Recovery image
PEI_RECOVERY_MEDIA_NOT_FOUND	PEI	86	Recovery image not found
PEI_RECOVERY_LOAD_FILE_DONE	PEI	87	Load Recovery Image completed
PEI_RECOVERY_START_FLASH	PEI	88	Start Flash BIOS with Recovery image
PEI_ENTER_DXEIPL	PEI	89	Loading BIOS image to RAM
PEI_FINDING_DXE_CORE	PEI	8A	Loading DXE core
PEI_GO_TO_DXE_CORE	PEI	8B	Enter DXE core

NOTE: The color bar items indicate 3rd party related functions that are platform dependent.

DXE Phase POST Code Table:

Functionality Name (Include PostCode.h)	Phase	PostCode	Description
DXE_TCGDXE	DXE	40	TPM initial in DXE
DXE_SB_SPI_INIT	DXE	41	South bridge SPI initialization
DXE_CF9_RESET	DXE	42	Setup Reset service
DXE_SB_SERIAL_GPIO_INIT	DXE	43	South bridge Serial GPIO initialization
DXE_SMMACCESS	DXE	44	Setup SMM ACCE SS service
DXE_NB_INIT	DXE	45	North bridge Middle initialization
DXE_SIO_INIT	DXE	46	Super I/O DXE initialization
DXE_LEGACY_REGION	DXE	47	Setup Legacy Region service
DXE_SB_INIT	DXE	48	South Bridge Middle initialization
DXE_IDENTIFY_FLASH_DEVICE	DXE	49	Identify Flash device
DXE_FTW_INIT	DXE	4A	Fault Tolerant Write verification
DXE_VARIABLE_INIT	DXE	4B	Variable Service initialization
DXE_VARIABLE_INIT_FAIL	DXE	4C	Fail to initial Variable Service
DXE_MTC_INIT	DXE	4D	MTC Initial
DXE_CPU_INIT	DXE	4E	CPU Middle Initialization
DXE_MP_CPU_INIT	DXE	4F	Multi-processor MiddleInitialization
DXE_SMBUS_INIT	DXE	50	SMBUS Driver Initialization
DXE_SMART_TIMER_INIT	DXE	51	8259 Initialization
DXE_PCRTC_INIT	DXE	52	RTC Initialization
DXE_SATA_INIT	DXE	53	SATA Controller earlyInitialization
DXE_SMM_CONTROLLER_INIT	DXE	54	Setup SMM Control service
DXE_LEGACY_INTERRUPT	DXE	55	Setup Legacy Interrupt service
DXE_RELOCATE_SMBASE	DXE	56	Relocate SMM BASE
DXE_FIRST_SMI	DXE	57	SMI test
DXE_VTD_INIT	DXE	58	VTD Initial
DXE_BEFORE_CSM16_INIT	DXE	59	Legacy BIOS Initialization
DXE_AFTER_CSM16_INIT	DXE	5A	Legacy interrupt function Initialization
DXE_LOAD_ACPI_TABLE	DXE	5B	ACPI Table Initialization
DXE_SB_DISPATCH	DXE	5C	Setup SB SMM Dispatcher service
DXE_SB_IOTRAP_INIT	DXE	5D	Setup SB IOTRAP Service
DXE_SUBCLASS_DRIVER	DXE	5E	Build AMT Table
DXE_PPM_INIT	DXE	5F	PPM Initialization
DXE_HECIDRV_INIT	DXE	60	HECIDRV Initialization

NOTE: The color bar items indicate 3rd party related functions that are platform dependent.

BDS Phase POST Code Table:

Functionality Name (Include PostCode.h)	Phase	Post Code	Description
BDS_ENTER_BDS	BDS	10	Enter BDS entry
BDS_INSTALL_HOTKEY	BDS	11	Install Hotkey service
BDS_ASF_INIT	BDS	12	ASF Initialization
BDS_PCI_ENUMERATION_START	BDS	13	PCI enumeration
BDS_BEFORE_PCIE_INSTALL	BDS	14	PCI resource assign complete
BDS_PCI_ENUMERATION_END	BDS	15	PCI enumeration complete
BDS_CONNECT_CONSOLE_IN	BDS	16	Keyboard Controller, Keyboard and Mouse initialization
BDS_CONNECT_CONSOLE_OUT	BDS	17	Video device initialization
BDS_CONNECT_STD_ERR	BDS	18	Error report device initialization
BDS_CONNECT_USB_HC	BDS	19	USB host controller initialization
BDS_CONNECT_USB_BUS	BDS	1A	USB BUS driver initialization
BDS_CONNECT_USB_DEVICE	BDS	1B	USB device driver initialization
BDS_NO_CONSOLE_ACTION	BDS	1C	Console device initial fail
BDS_DISPLAY_LOGO_SYSTEM_INFO	BDS	1D	Display logo or system information
BDS_START_IDE_CONTROLLER	BDS	1E	IDE controller initialization
BDS_START_SATA_CONTROLLER	BDS	1F	SATA controller initialization
BDS_START_ISA_ACPI_CONTROLLER	BDS	20	SIO controller initialization
BDS_START_ISA_BUS	BDS	21	ISA BUS driver initialization
BDS_START_ISA_FDD	BDS	22	Floppy device initialization
BDS_START_ISA_SEIRAL	BDS	23	Serial device initialization
BDS_START_IDE_BUS	BDS	24	IDE device initialization
BDS_START_AHCI_BUS	BDS	25	AHCI device initialization
BDS_CONNECT_LEGACY_ROM	BDS	26	Dispatch option ROMs
BDS_ENUMERATE_ALL_BOOT_OPTION	BDS	27	Get boot device information
BDS_END_OF_BOOT_SELECTION	BDS	28	End of boot selection
BDS_ENTER_SETUP	BDS	29	Enter Setup Menu
BDS_ENTER_BOOT_MANAGER	BDS	2A	Enter Boot manager
BDS_BOOT_DEVICE_SELECT	BDS	2B	Try to boot system to OS
BDS_EFI64_SHADOW_ALL_LEGACY_ROM	BDS	2C	Shadow Misc Option ROM
BDS_ACPI_S3SAVE	BDS	2D	Save S3 resume required data in RAM
BDS_READY_TO_BOOT_EVENT	BDS	2E	Last Chipset initial before boot to OS
BDS_GO_LEGACY_BOOT	BDS	2F	Start to boot Legacy OS
BDS_GO_UEFI_BOOT	BDS	30	Start to boot UEFI OS
BDS_LEGACY16_PREPARE_TO_BOOT	BDS	31	Prepare to Boot to Legacy OS
BDS_EXIT_BOOT_SERVICES	BDS	32	Send END of POST Message to ME via HECI
BDS_LEGACY_BOOT_EVENT	BDS	33	Last Chipset initial before boot to Legacy OS.
BDS_ENTER_LEGACY_16_BOOT	BDS	34	Ready to Boot Legacy OS.

Functionality Name (Include\ PostCode.h)	Phase	Post Code	Description
BDS_RECOVERY_START_FLASH	BDS	35	Fast Recovery Start Flash.

NOTE: The color bar items indicate 3rd party related functions that are platform dependent.

PostBDS POST Code Table

Functionality Name (Include\ PostCode.h)	Phase	Post Code	Description
POST_BDS_NO_BOOT_DEVICE	POST_BDS	F9	No Boot Device
POST_BDS_START_IMAGE	POST_BDS	FB	UEFI Boot Start Image
POST_BDS_ENTER_INT19	POST_BDS	FD	Legacy 16 boot entry
POST_BDS_JUMP_BOOT_SECTOR	POST_BDS	FE	Try to Boot with INT 19

S3 Functions POST Code Table

Functionality Name (Include\ PostCode.h)	Phase	Post Code	Description
POST_BDS_NO_BOOT_DEVICE	POST_BDS	F9	No Boot Device
POST_BDS_START_IMAGE	POST_BDS	FB	UEFI Boot Start Image
POST_BDS_ENTER_INT19	POST_BDS	FD	Legacy 16 boot entry
POST_BDS_JUMP_BOOT_SECTOR	POST_BDS	FE	Try to Boot with INT 19

ACPI Functions POST Code Table

Functionality Name (Include\ PostCode.h)	Phase	Post Code	Description
ASL_ENTER_S1	ASL	51	Prepare to enter S1
ASL_ENTER_S3	ASL	53	Prepare to enter S3
ASL_ENTER_S4	ASL	54	Prepare to enter S4
ASL_ENTER_S5	ASL	55	Prepare to enter S5
ASL_WAKEUP_S1	ASL	E1	System wakeup from S1
ASL_WAKEUP_S3	ASL	E3	System wakeup from S3
ASL_WAKEUP_S4	ASL	E4	System wakeup from S4

SMM Functions POST Code Table

Functionality Name (Include\ PostCode.h)	Phase	Post Code	Description
SMM_IDENTIFY_FLASH_DEVICE	SMM	0xA0	Identify Flash device in SMM
SMM_SMM_PLATFORM_INIT	SMM	0xA2	SMM service initial
SMM_ACPI_ENABLE_START	SMM	0xA6	OS call ACPI enable function
SMM_ACPI_ENABLE_END	SMM	0xA7	ACPI enable function complete
SMM_S1_SLEEP_CALLBACK	SMM	0xA1	Enter S1
SMM_S3_SLEEP_CALLBACK	SMM	0xA3	Enter S3
SMM_S4_SLEEP_CALLBACK	SMM	0xA4	Enter S4
SMM_S5_SLEEP_CALLBACK	SMM	0xA5	Enter S5

Functionality Name (Include\ PostCode.h)	Phase	Post Code	Description
SMM_ACPI_DISABLE_START	SMM	0xA8	OS call ACPI disable function
SMM_ACPI_DISABLE_END	SMM	0xA9	ACPI disable function complete

InsydeH2ODDT Debugger POST Code Table

Functionality Name (Include\ PostCode.h)	PostCode	Description
Used by Insyde debugger	0x0D	Waiting for device connect
Used by Insyde debugger	0xD0	Waiting for device connect
Used by Insyde debugger	0xD1	InsydeH2ODDT Ready
Used by Insyde debugger	0xD2	EHCI not found
Used by Insyde debugger	0xD3	Debug port connect low speed device
Used by Insyde debugger	0xD4	DDT Cable become low speed device
Used by Insyde debugger	0xD5	DDT Cable Transmission Error (Get descriptor fail)
Used by Insyde debugger	0xD6	DDT Cable Transmission Error (Set Debug mode fail)
Used by Insyde debugger	0xD7	DDT Cable Transmission Error (Set address fail)

Jumper and Connector Locations

Top View

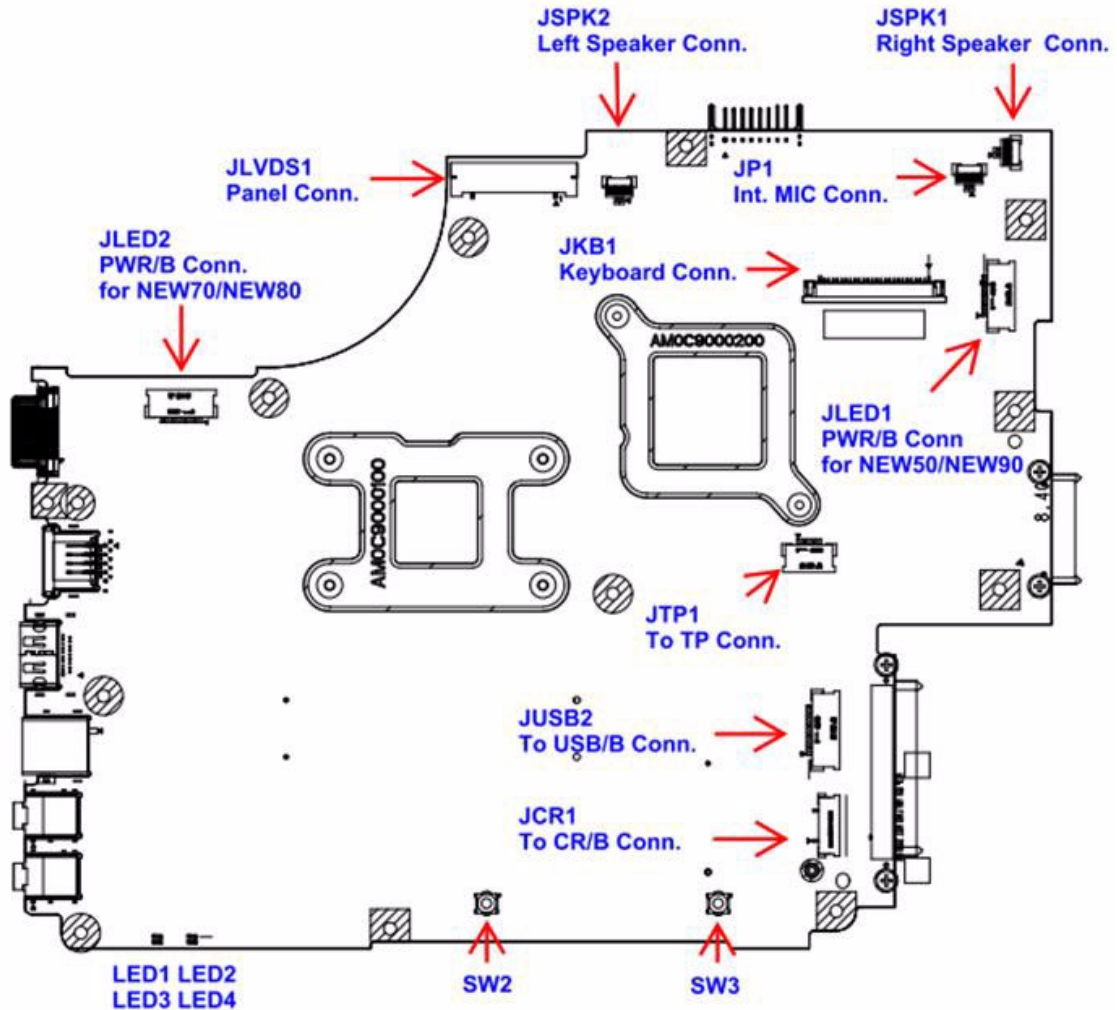

Item	Description	Item	Description
JLVDS1	Connect to LED / CCFL Panel	JLED1	Connect to Powerboard (FFC)
JSPK2	Connect to Left Speaker	JLED2	Connect to Powerboard (FFC)
JSPK1	Connect to Right Speaker	JP1	Connect to internal MIC
JKB1	Connect to Keyboard	SW2/SW3	Left button / Right button
JTP1	Connect to Touch pad (FFC)	LED1/LED3	Power State Indicator
JUSB2	Connect to Power USB Board (FFC)	LED2/LED4	Battery Charging Indicator
JCR1	Connect Card Reader Board (FFC)		

Bottom View

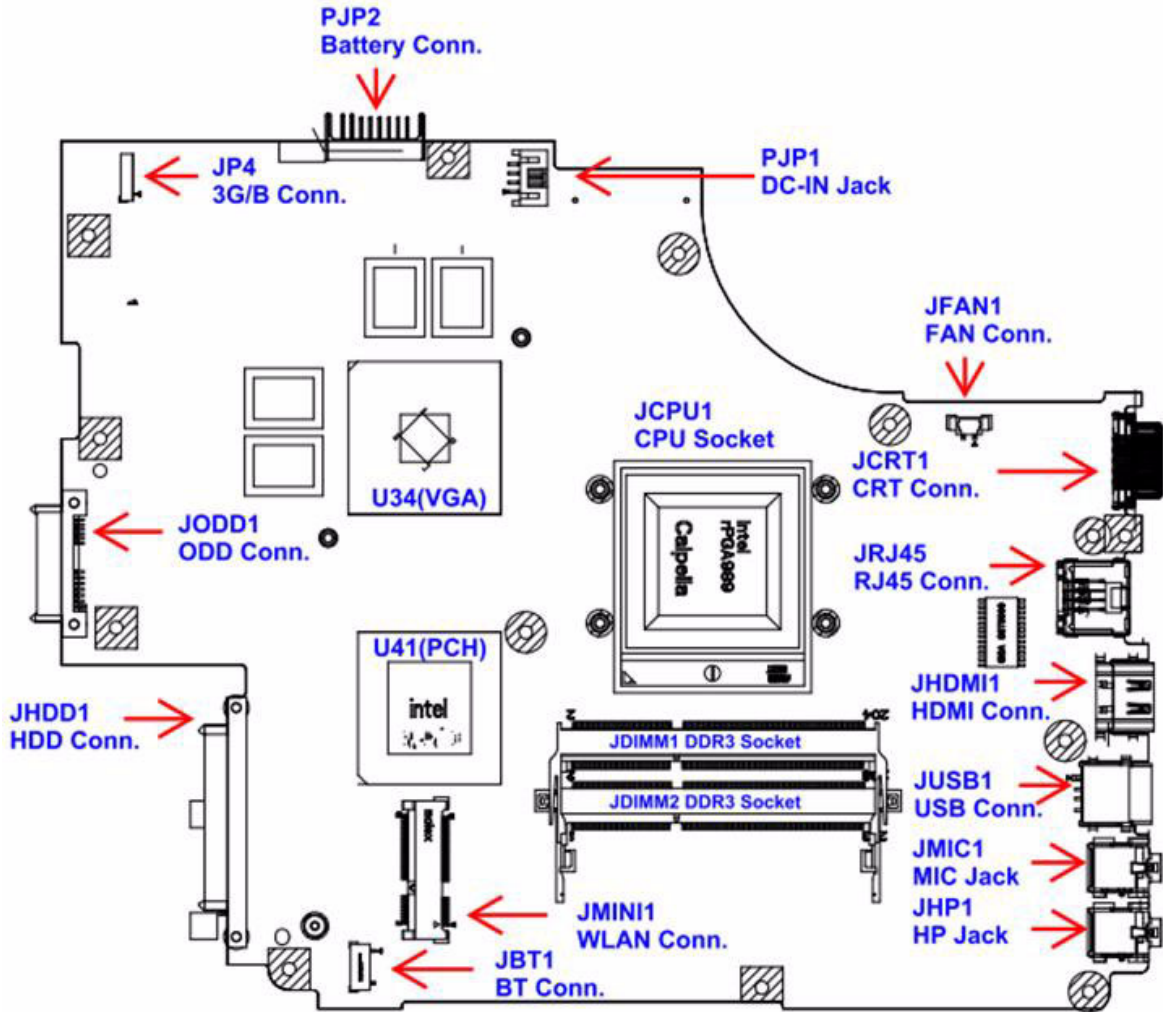

Item	Description	Item	Description
PJP2	Connect to Battery	JHP1	Connect to external headphone
PJP1	DC-IN jack	JBT1	Connect to BT
JDIMM1/ JDIMM2	DDR3 memory socket	JHDD1	Connect to SATAHDD
JCRT1	Connect to external CRT	JODD1	Connect to SATAODD
JRJ45	RJ45 LAN	JP4	Connect to 3G board
JHDMI1	HDMI connector	JFAN1	Connect to FAN
JMINI1	Connect to WLAN	JCPU1	CPU socket
JUSB1	USB connector	U41	PCH
JMIC1	Connect to external microphone		

USB/B Board

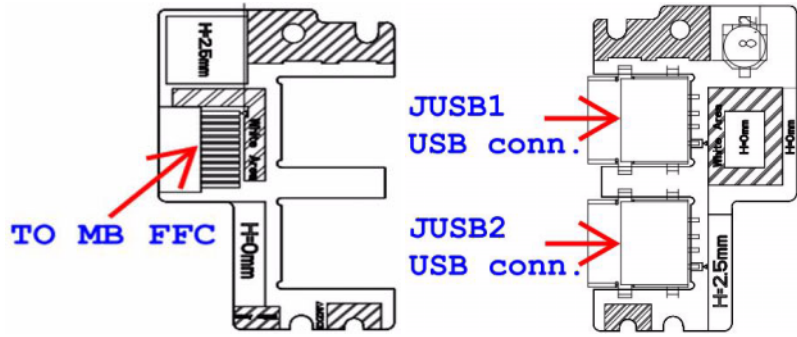

ITEM	DESCRIPTION
JUSB1/JUSB2	USB Connector

Power Board

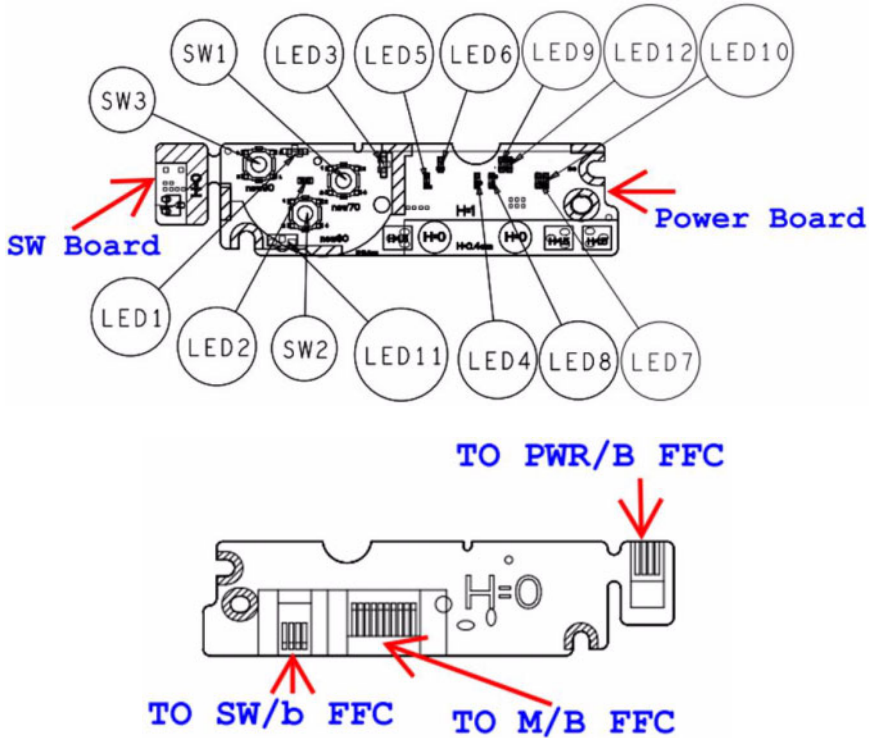

ITEM	DESCRIPTION	ITEM	DESCRIPTION
LED1	For NEW70 ON/OFF LED	LED9	For NEW50 WWAN LED
LED2	For NEW80 ON/OFF LED	LED10	For NEW70 WLAN LED
LED3	For NEW90 ON/OFF LED	LED11	For NEW50 POWER LED
LED4	For NEW70 MEDIA LED	LED12	For NEW50/NEW90 WLAN LED
LED5	For NEW80 MEDIA LED	SW1	For NEW70 Power BTN
LED6	For NEW50/NEW90 MEDIA LED	SW2	For NEW80 Power BTN
LED7	For NEW70 WWAN LED	SW3	For NEW90 Power BTN
LED8	For NEW80 WLAN LED		

3G/B Board

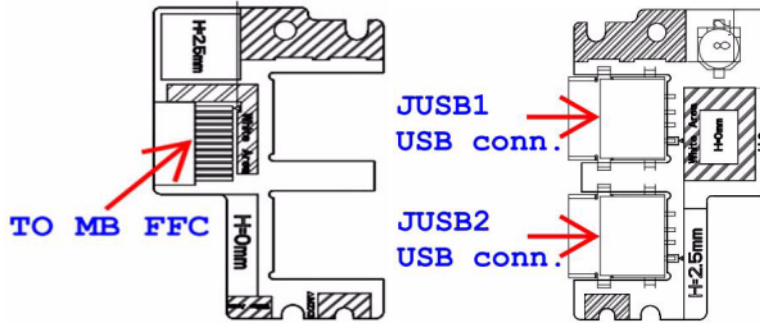

ITEM	DESCRIPTION
JMINI2	Connect to WWAN
JSIM1	SIM card connector
JP1	Connector to MB (FFC)

CR/B Board

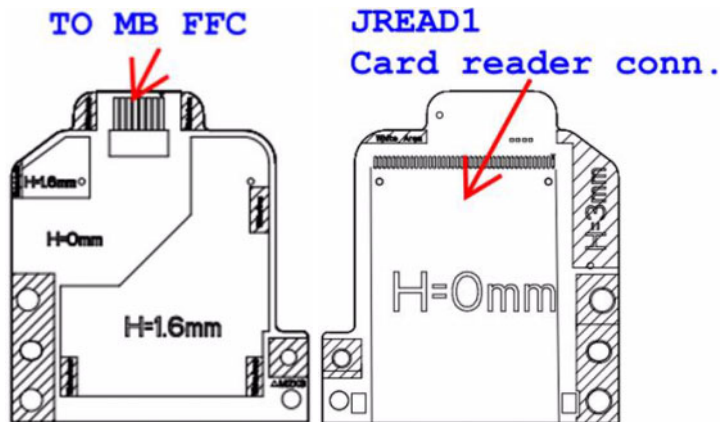

ITEM	DESCRIPTION
JREAD1	Card reader connector

Clearing Password Check and BIOS Recovery

This section provides you with the standard operating procedures of clearing password and BIOS recovery for the Packard Bell EasyNote TM86/TM87/TM89. The machine provides one Hardware Open Gap on main board for clearing password check, and one Hotkey for enabling BIOS Recovery.

Clearing Password Check

Steps for Clearing BIOS Password Check

If users set BIOS Password (Supervisor Password and/or User Password) for a security reason, BIOS will ask the password during systems POST or when systems enter to BIOS Setup menu. However, once it is necessary to bypass the password check, users need to short the HW Gap to clear the password by the following steps:

1. Power Off the system, and remove HDD, AC and Battery from the machine.
2. Disconnect the RTC Battery cable and locate the RTC_RST jumper.
3. Use an electric conductivity tool to short the two points of the HW Gap.
4. Plug in AC, keeping the HW Gap shorted. Press Power Button until BIOS POST is finished, then remove the tool from the HW Gap.
5. Restart the system. Press **F2** key to enter BIOS Setup menu.
6. If there is no Password request, BIOS Password is cleared. Otherwise, please follow the steps and try again.

NOTE: These steps are only for clearing BIOS Password (Supervisor Password and User Password).

Clear CMOS Jumper

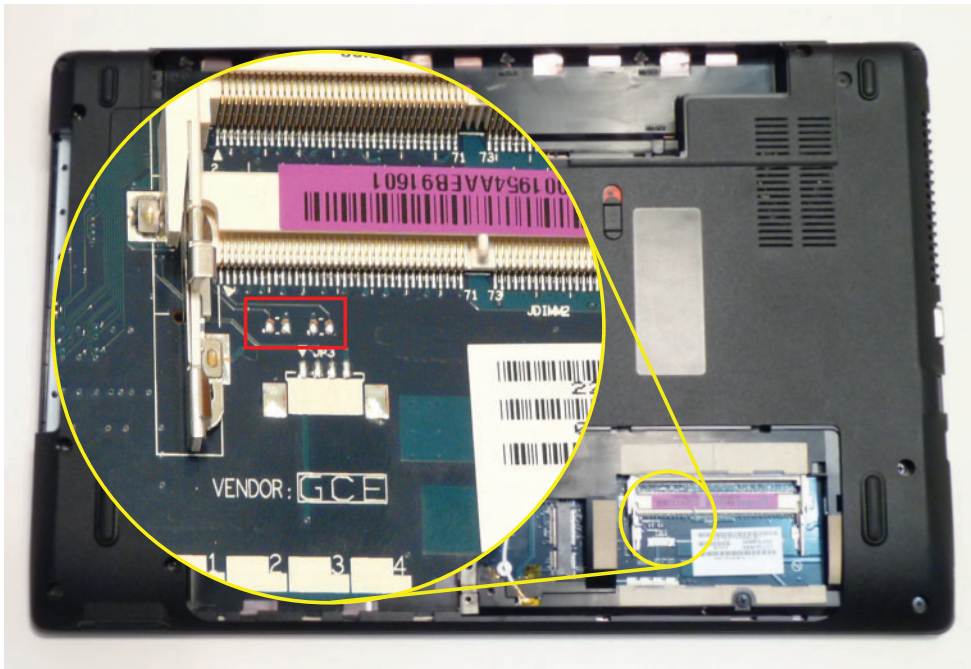

Item	Description
RTC_RST	Clear CMOS Jumper

BIOS Recovery by Crisis Disk

BIOS Recovery Boot Block:

BIOS Recovery Boot Block is a special block of BIOS. It is used to boot up the system with minimum BIOS initialization. Users can enable this feature to restore the BIOS firmware to a successful one once the previous BIOS flashing process failed.

BIOS Recovery Hotkey:

The system provides a function hotkey: **Fn+Esc**, for enable BIOS Recovery process when system is powered on during BIOS POST. To use this function, it is strongly recommended to have the AC adapter and Battery present. If this function is enabled, the system will force the BIOS to enter a special BIOS block, called Boot Block.

Steps for BIOS Recovery from USB Storage:

Before doing this, prepare the Crisis USB key. The Crisis USB key could be made by executing the Crisis Disk program in another system with Windows 7 OS.

Follow the steps below:

1. Format the USB storage disk using the Fast Format option.
2. Save ROM file (file name: **NEW70x64.fd**) to the root directory of USB storage. Make sure that there is no other BIOS file saved in the same directory.
3. Plug USB storage into USB port.
4. Press **Fn + ESC** button then plug in AC power.
The Power button flashes once.
5. Press **Power** button to initiate system CRISIS mode.
When CRISIS is complete, the system auto restarts with a workable BIOS.
6. Update the latest version BIOS for this machine by regular BIOS flashing process.

FRU (Field Replaceable Unit) List

This chapter gives you the FRU (Field Replaceable Unit) listing in global configurations of Packard Bell EasyNote TM86/TM87/TM89. Refer to this chapter whenever ordering for parts to repair or for RMA (Return Merchandise Authorization).

Please note that WHEN ORDERING FRU PARTS, you should check the most up-to-date information available on your regional web or channel. For whatever reasons a part number change is made, it will not be noted on the printed Service Guide. For ACER AUTHORIZED SERVICE PROVIDERS, your Acer office may have a DIFFERENT part number code from those given in the FRU list of this printed Service Guide. You MUST use the local FRU list provided by your regional Acer office to order FRU parts for repair and service of customer machines.

NOTE: To scrap or to return the defective parts, you should follow the local government ordinance or regulations on how to dispose it properly, or follow the rules set by your regional Acer office on how to return it.

EasyNote Exploded Diagrams

Main Assembly

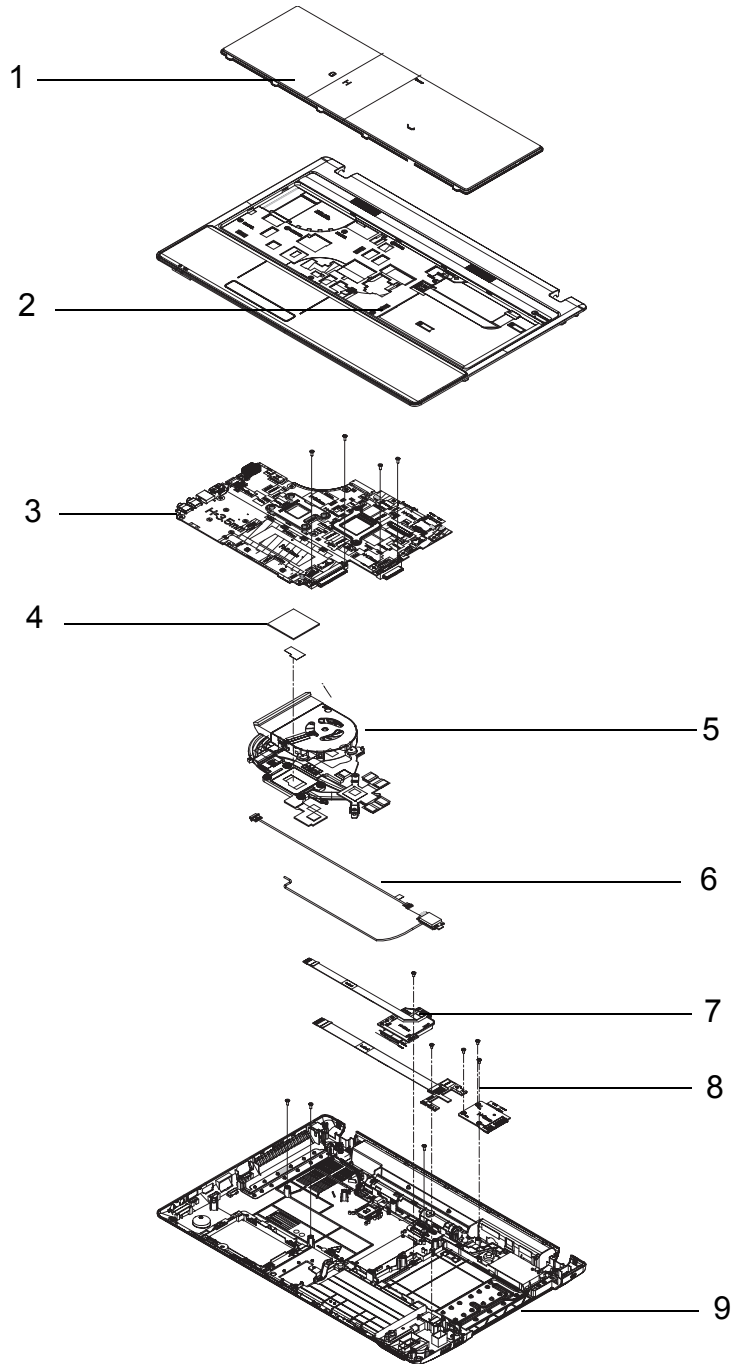

No.	Description	Acer P/N	No.	Description	Acer P/N
1	Keyboard	KB.1170G.083	6	3G Module	TBD
2	Upper Cover	60.WJ802.001	7	Card Reader	55.WJ802.002
3	Mainboard	MB.WJU02.001	8	USB Board	55.WJ802.003
4	CPU	KC.52001.DMP	9	Lower Cover	60.WJ802.002
5	Thermal Module	60.WJ802.006			

Upper Assembly

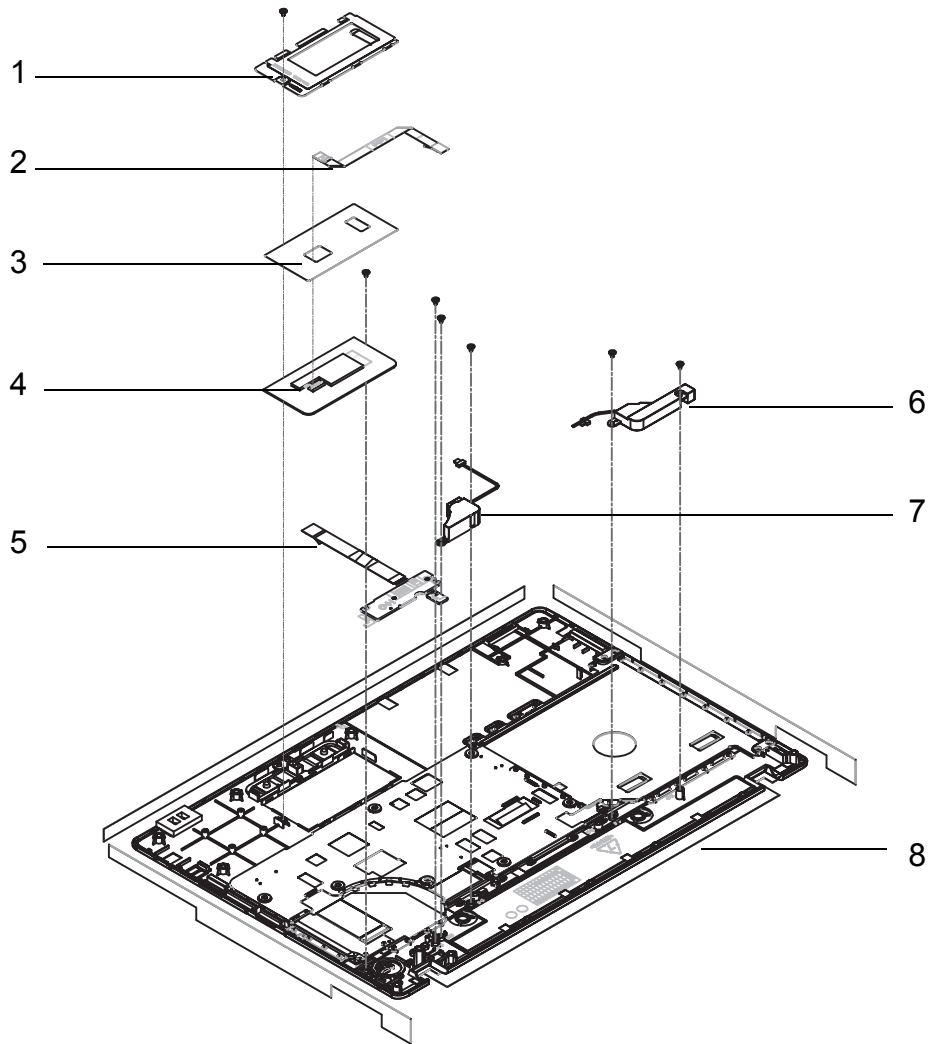

No.	Description	Acer P/N
1	Touchpad Bracket	33.WJ802.001
2	Touchpad Cable	50.WJ802.003
3	Touchpad Board	TBD
4	Touchpad Assy	TBD
5	Power Board	55.WJ802.001
6	Speaker Right	23.WJ802.002
7	Speaker Left	23.WJ802.003
8	Upper Cover	60.WJ802.001

LCD Assembly

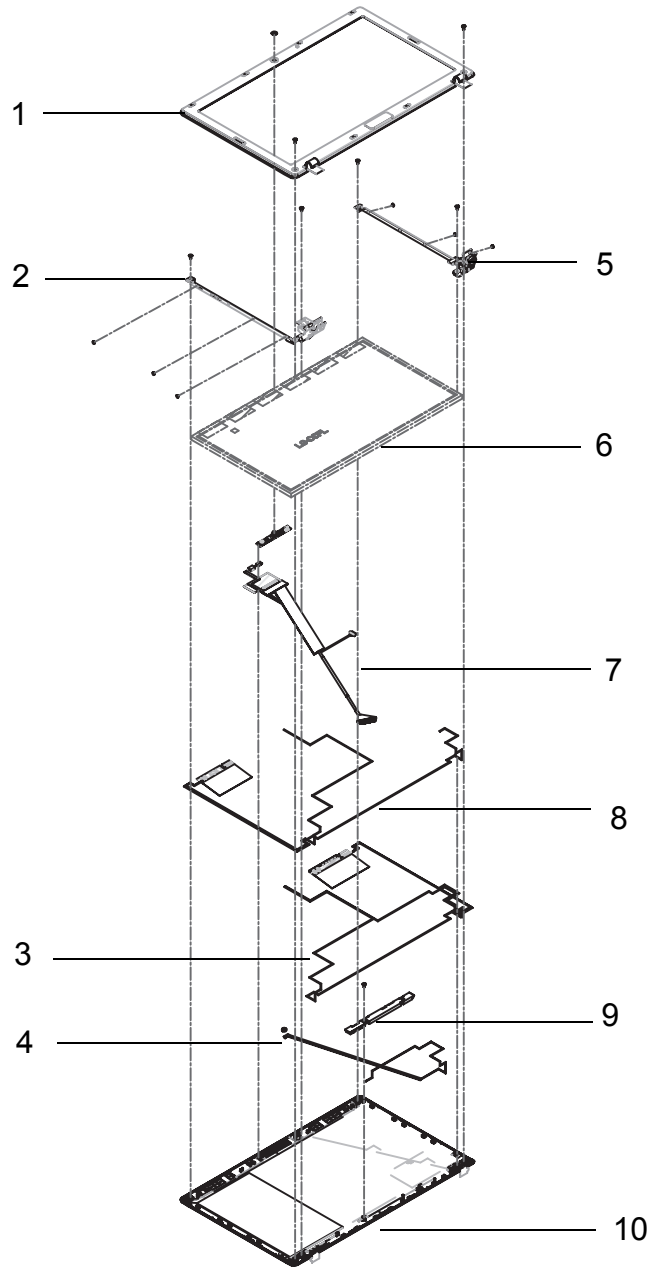

No.	Description	Acer P/N	No.	Description	Acer P/N
1	LCD Bezel	60.WJ802.004	6	LCD Panel	LK.15605.010
2	LCD Bracket (L)	33.WJ802.004	7	LVDS Cable	50.WJ802.006
3	Antenna Cable (Main)	50.WJ802.004	8	Antenna Cable (Aux)	50.WJ802.005
4	Microphone Cable	23.WJ802.001	9	Camera Module	57.WJ802.001
5	LCD Bracket (R)	33.WJ802.004	10	LCD Cover	60.BHN02.001

FRU List

CATEGORY	Acer Description	AcerPN
BOARD		
	FOXCONN BLUETOOTH BRM 2046 BT2.1 (T60H928.33) F/W:861	BH.21100.004
		TBD
	FOXCONN BLUETOOTH ATH AR3011	BH.21100.005
	POWER BOARD	55.WJ802.001
	CARD READER BOARD	55.WJ802.002
	USB BOARD	55.WJ802.003
	FOXCONN WIRELESS LAN ATHEROS HB93 2X2 BGN (HM)	NI.23600.062
	LITEON WIRELESS LAN ATHERIS HB93 2X2 BGN (HM) WN6602AH	NI.23600.063
	LITEON WIRELESS LAN REALTEK 8192SE BGN WN6603LH(2X2 BGN)	NI.23600.065
CABLE		
	BLUE TOOTH CABLE-8PIN	50.WJ802.001
	BLUE TOOTH CABLE-6PIN	50.WJ802.002
	TP FFC	50.WJ802.003
	DC-IN CABLE-65W	50.WJ802.010
	DC-IN CABLE-90W	50.WJ702.001
	POWER CORD US 3 PIN	27.TAVV5.001
	POWER CORD EU 3 PIN	27.TAVV5.002
	POWER CORD AUS 3 PIN	27.TAVV5.003
	POWER CORD UK 3 PIN	27.TAVV5.004
	POWER CORD CHINA 3 PIN	27.TAVV5.005
	POWER CORD SWISS 3 PIN	27.TAVV5.006
	POWER CORD ITALIAN 3 PIN	27.TAVV5.007
	POWER CORD DENMARK 3 PIN	27.TAVV5.008
	POWER CORD JP 3 PIN	27.TAVV5.009
	POWER CORD SOUTH AFRICA 3 PIN	27.TAVV5.010
	POWER CORD KOREA 3 PIN	27.TAVV5.011
	POWER CORD ISRAEL 3 PIN	27.TAVV5.012
	POWER CORD INDIA 3 PIN	27.TAVV5.013
POWER CORD TWN 3 PIN	27.TAVV5.014	

CATEGORY	Acer Description	AcerPN
	POWER CORD ARGENTINA 3 PIN	27.APV02.001
CASE/COVER/BRACKET ASSEMBLY		
	UPPER CASE ASSY, INCL. TP/TP MYLAR-SLIVER	60.WJ802.001
	UPPER CASE ASSY, INCL. TP/TP MYLAR-RED	60.WJL02.001
	UPPER CASE ASSY, INCL. TP/TP MYLAR-BLUE	60.WJU02.001
	LOWER CASE	60.WJ802.002
	LOGIC LOWER DOOR	42.WJ802.001
	3G DOOR	42.WJ802.002
	TP BRACKET	33.WJ802.001
	HDD CARRIER	33.WJ802.002
	ODD BRACKET	33.WJ802.003
	ODD BEZEL-SM	42.WJ802.003
	ODD BEZEL-BD(HIGH SPEED)	42.WJ802.004

CATEGORY	Acer Description	AcerPN
KEYBOARD		
	Keyboard GATEWAY GP-7Tv2 SJM51 Internal 17 Standard 103KS White US International	KB.I170G.083
	Keyboard GATEWAY GP-7Tv2 SJM51 Internal 17 Standard 103KS White Greek	KB.I170G.068
	Keyboard GATEWAY GP-7Tv2 SJM51 Internal 17 Standard 103KS White Arabic	KB.I170G.059
	Keyboard GATEWAY GP-7Tv2 SJM51 Internal 17 Standard 103KS White Chinese	KB.I170G.063
	Keyboard GATEWAY GP-7Tv2 SJM51 Internal 17 Standard 103KS White Russian	KB.I170G.075
	Keyboard GATEWAY GP-7Tv2 SJM51 Internal 17 Standard 103KS White US International w/ Hebrew	KB.I170G.084
	Keyboard GATEWAY GP-7Tv2 SJM51 Internal 17 Standard 103KS White Thailand	KB.I170G.080
	Keyboard GATEWAY GP-7Tv2 SJM51 Internal 17 Standard 104KS White UK	KB.I170G.082
	Keyboard GATEWAY GP-7Tv2 SJM51 Internal 17 Standard 104KS White German	KB.I170G.067
	Keyboard GATEWAY GP-7Tv2 SJM51 Internal 17 Standard 104KS White Swiss/G	KB.I170G.079
	Keyboard GATEWAY GP-7Tv2 SJM51 Internal 17 Standard 104KS White Belgium	KB.I170G.060
	Keyboard GATEWAY GP-7Tv2 SJM51 Internal 17 Standard 104KS White Danish	KB.I170G.064
	Keyboard GATEWAY GP-7Tv2 SJM51 Internal 17 Standard 104KS White Italian	KB.I170G.070
	Keyboard GATEWAY GP-7Tv2 SJM51 Internal 17 Standard 104KS White French	KB.I170G.066
	Keyboard GATEWAY GP-7Tv2 SJM51 Internal 17 Standard 104KS White Hungarian	KB.I170G.069
	Keyboard GATEWAY GP-7Tv2 SJM51 Internal 17 Standard 104KS White Norwegian	KB.I170G.073
	Keyboard GATEWAY GP-7Tv2 SJM51 Internal 17 Standard 104KS White Portuguese	KB.I170G.074
	Keyboard GATEWAY GP-7Tv2 SJM51 Internal 17 Standard 104KS White Spanish	KB.I170G.077
	Keyboard GATEWAY GP-7Tv2 SJM51 Internal 17 Standard 104KS White US w/ Canadian French	KB.I170G.085
	Keyboard GATEWAY GP-7Tv2 SJM51 Internal 17 Standard 104KS White Turkish	KB.I170G.081
	Keyboard GATEWAY GP-7Tv2 SJM51 Internal 17 Standard 104KS White Sweden	KB.I170G.078
	Keyboard GATEWAY GP-7Tv2 SJM51 Internal 17 Standard 104KS White FR/Arabic	KB.I170G.065
Keyboard GATEWAY GP-7Tv2 SJM51 Internal 17 Standard 104KS White Nordic	KB.I170G.072	
Keyboard GATEWAY GP-7Tv2 SJM51 Internal 17 Standard 104KS White SLO/CRO	KB.I170G.076	

CATEGORY	Acer Description	AcerPN
	Keyboard GATEWAY GP-7Tv2 SJM51 Internal 17 Standard 104KS White CZ/SK	KB.I170G.062
	Keyboard GATEWAY GP-7Tv2 SJM51 Internal 17 Standard 104KS White Brazilian Portuguese	KB.I170G.061
LCD		
	LCD COVER IMR PB-SLIVER	60.BHN02.001
	LCD COVER IMR PB-RED	60.BHY02.001
	LCD COVER IMR PB-BLUE	60.BJ202.001
	LCD BEZEL FOR W/CMOS PB	60.BHN02.002
	LCD BEZEL FOR W/O CMOS PB	60.BHN02.003
	ANTENNA WLAN-MAIN	50.WJ802.004
	ANTENNA WLAN-AUX	50.WJ802.005
	LCD CABLE FOR W/CMOS	50.WJ802.006
	LCD CABLE FOR W/O CMOS	50.WJ802.007
	LED CABLE FOR W/CMOS	50.WJ802.008
	LED CABLE FOR W/O CMOS	50.WJ802.009
	LCD BRACKET R&L	33.WJ802.004
	LED BRACKET R&L	33.WJ802.005
	CAMERA 1.3M	57.WJ802.001
	INVERTER	55.WJ802.004
MAINBOARD		
	Mainboard SJV51_CP Intel LF	MB.WJU02.001
	Mainboard SJV51_CP LF	MB.WJM02.001
	Mainboard SJV51_CP NV LF	MB.BJY02.001
		TBD
		same as A2

CATEGORY	Acer Description	AcerPN
HEATSINK		
	THERMAL MOUDLE-UMA	60.WJ802.006
	THERMAL MOUDLE-PARK	60.WJ702.001
	THERMAL MOUDLE-MADISON	60.WJF02.001
SPEAKER		
	MIC SET	23.WJ802.001
	SPEAKER R	23.WJ802.002
	SPEAKER L	23.WJ802.003
MISCELLANEOUS		
	LCD SCREW PAD	47.WJ802.001
CPU/PROCESSOR		
	CPU INTEL CORE I5 520M 2.4G 3M	KC.52001.DMP
	CPU INTEL CORE I5 430M PGA 2.26G ARD, UP TO SC 2.53G, 3M L3	KC.43001.DMP
	CPU INTEL CORE I3 330M PGA 2.13G 35W ARRANDALE, TJ90, VT, 3M L3	KC.33001.DMP
LCD PANEL		
	LED LCD AUO 15.6"W WXGA GLARE B156XW02 V2 LF 200NIT 8MS 500:1 (POWER SAVING)	LK.15605.010
	LED LCD LPL 15.6"W WXGA GLARE LP156WH2-TLE1 LF 220NIT 8MS 400:1	LK.15608.002
	LED LCD CMO 15.6"W WXGA GLARE N156B6-L0B LF 220NIT 8MS 650:1	LK.1560D.010
	LED LCD INNOLUX 15.6"W WXGA GLARE BT156GW01 V2 LF 220NIT 8MS 600:1	LK.1560N.001
HDD/HARD DISK DRIVE		
	HDD HGST 2.5" 5400RPM 160GB HTS545016B9A300 PANTHER B SATA LF F/W:C60F DISK IMBALANCE CRITERIA = 0.014G-CM	KH.16007.026
	HDD HGST 2.5" 5400RPM 250GB HTS545025B9A300 PANTHER B SATA LF F/W:C60F DISK IMBALANCE CRITERIA = 0.014G-CM	KH.25007.016
	HDD HGST 2.5" 5400RPM 320GB HTS545032B9A300 PANTHER B SATA LF F/W:C60F DISK IMBALANCE CRITERIA = 0.014G-CM	KH.32007.008

CATEGORY	Acer Description	AcerPN
	HDD SEAGATE 2.5" 5400RPM 500GB ST9500325AS WYATT SATA LF F/W:0001SDM1	KH.50001.011
	HDD HGST 2.5" 5400RPM 500GB HTS545050B9A300 PANTHER B SATA LF F/W:C60F DISK IMBALANCE CRITERIA = 0.014G-CM	KH.50007.010
	HDD SEAGATE 2.5" 5400RPM 160GB ST9160314AS WYATT SATA LF F/W:0001SDM1	KH.16001.042
	HDD SEAGATE 2.5" 5400RPM 320GB ST9320325AS WYATT SATA LF F/W:0001SDM1	KH.32001.017
	HDD WD 2.5" 5400RPM 160GB WD1600BEVT-22A23T0 , WD, ML320S SATA 8MB LF F/W:01.01A01	KH.16008.027
	HDD WD 2.5" 5400RPM 250GB WD2500BEVT-22A23T0, WD, ML320S SATA 8MB LF F/W:01.01A01.	KH.25008.025
	HDD WD 2.5" 5400RPM 320GB WD3200BEVT-22A23T0,ML320S,WD SATA 8MB LF F/W:01.01A01	KH.32008.019
	HDD TOSHIBA 2.5" 5400RPM 160GB MK1665GSX, CAPRICORN BS, 320G/P SATA 8MB LF F/W:GJ002J	KH.16004.008
	HDD TOSHIBA 2.5" 5400RPM 320GB CAPRICORN BS ,MK3265GSX SATA 8MB LF F/W:GJ002J	KH.32004.004
	HDD TOSHIBA 2.5" 5400RPM 500GB MK5065GSX,CAPRICORN BS, 320G/P SATA 8MB LF F/W:GJ002J	KH.50004.002
	HDD TOSHIBA 2.5" 5400RPM 250GB MK2565GSX, CAPRICORN BS, 320G/P SATA 8MB LF F/W:GJ002J	KH.25004.005
DVD RW DRIVE		
	ODD TOSHIBA SUPER-MULTI DRIVE 12.7MM TRAY DL 8X TS-L633C LF W/O BEZEL SATA (HF + WINDOWS 7)	KU.00801.035
	ODD HLDS SUPER-MULTI DRIVE 12.7MM TRAY DL 8X GT30N LF W/O BEZEL SATA (HF + WINDOWS 7)	KU.0080D.048
	ODD PANASONIC SUPER-MULTI DRIVE 12.7MM TRAY DL 8X UJ890A LF W/O BEZEL SATA (HF + WINDOWS 7)	KU.00807.070
	ODD SONY SUPER-MULTI DRIVE 12.7MM TRAY DL 8X AD-7585H LF W/O BEZEL SATA (HF + WINDOWS 7)	KU.0080E.027
	ODD PLDS SUPER-MULTI DRIVE 12.7MM TRAY DL 8X DS-8A4SH LF W/O BEZEL SATA (HF + WINDOWS 7)	KU.0080F.006
BD COMBO DRIVE		
	ODD PLDS BD COMBO 12.7MM TRAY DL 4X DS-4E1S LF W/O BEZEL SATA (WINDOWS 7)	KO.0040F.003
	ODD HLDS BD COMBO 12.7MM TRAY DL 4X CT21N LF W/O BEZEL 1.00 SATA (HF + WINDOWS 7)	KO.0040D.004
	ODD SONY BD COMBO 12.7MM TRAY DL 4X BC-5500H LF W/O BEZEL SATA (HF + WINDOWS 7)	KO.0040E.003

CATEGORY	Acer Description	AcerPN
BATTERY		
	BATTERY SANYO AS10D LI-ION 3S2P SANYO 6 CELL 4400MAH MAIN COMMON ID:AS10D31	BT.00603.111
	BATTERY SAMSUNG AS10D LI-ION 3S2P SAMSUNG 6 CELL 4400MAH MAIN COMMON ID:AS10D61	BT.00606.008
	BATTERY SIMPLO AS10D LI-ION 3S2P PANASONIC 6 CELL 4400MAH MAIN COMMON ID:AS10D71	BT.00607.125
	BATTERY SIMPLO AS10D LI-ION 3S2P SAMSUNG 6 CELL 4400MAH MAIN COMMON ID:AS10D	BT.00607.127
MEMORY		
	MEMORY SAMSUNG SO-DIMM DDRIII 1066 2GB M471B5673EH1-CF8 LF 128*8 0.055UM	KN.2GB0B.012
	MEMORY SAMSUNG SO-DIMM DDRIII 1066 1GB M471B2873EH1-CF8 LF 64*16 0.055UM	KN.1GB0B.028
	MEMORY ELPIDA SO-DIMM DDRIII 1066 2GB EBJ21UE8BDS0-AE-F LF 128*8 0.065UM	KN.2GB09.006
	MEMORY ELPIDA SO-DIMM DDRIII 1066 1GB EBJ10UE8BDS0-AE-F LF 128*8 0.065UM	KN.1GB09.012
ADAPTER		
	ADAPTER LITE-ON 90W 19V 1.7X5.5X11 BLUE PA-1900-34AR, LV5 LED LF	AP.09003.021
	ADAPTER DELTA 90W 19V 1.7X5.5X11 BLUE ADP-90CD DB A, LV5 LED LF	AP.09001.027
	ADAPTER DELTA 65W 19V 1.7X5.5X11 YELLOW ADP-65JH DB A, LV5 LED LF	AP.06501.026
	ADAPTER LITE-ON 65W 19V 1.7X5.5X11 YELLOW PA-1650-22AC LV5 LED LF	AP.06503.024
	ADAPTER HIPRO 65W 19V 1.7X5.5X11 YELLOW HP-A0652R3B 1LF, LV5 LED LF	AP.0650A.012
	ADAPTER HIPRO 90W 19V 1.7X5.5X11 BLUE HP-A0904A3 B1LF, LV5 LED LF	AP.0900A.005

Screw List

CATEGORY	DESCRIPTION	Acer PN
SCREW		
	SCREW 2.5D 5L K 5.5D ZK NL CR3	86.WJ802.001
	SCREW 2.45D 8.0L K 5.5D 0.8T ZK NL	86.WJ802.002
	SCREW 2.5D 6L K 5.5D NI NL	86.WJ802.003
	SCREW 1.98D 3.0L K 4.6D 0.8T ZK NL	86.WJ802.004
	SCREW 3.0D 3.0L K 4.9D NI	86.WJ802.005
	SCREW ASSY CPU THERMAL	86.WJ802.006

Model Definition and Configuration

Packard Bell EasyNote TM86

Model	Acer Part No	RO	Country	Description
ENTM86-434G64Bn	LX.BJX02.002	EMEA	France	ENTM86-434G64Bn W7HP64BTFR1 N11PGV2H1GBCsk_3V3 2*2G/640/6L2.2/5R/CB_bgn_1.3C_GEs_FR51 EASYNOTE_TM86-JO-228FR
ENTM86-334G50Mn	S2.BJX02.002	WW	WW	ENTM86-334G50Mn W7HP64BWW2 N11PGV2H1GBCsk_3V3 2*2G/500_L/BT/6L2.2/5R/CB_bgn_1.3C_GEs_EN11
ENTM86-434G64Mn	LX.BJX02.001	EMEA	France	ENTM86-434G64Mn W7HP64BTFR1 N11PGV2H1GBCsk_3V3 2*2G/640/6L2.2/5R/CB_bgn_1.3C_GEs_FR51 EASYNOTE_TM86-JO-205FR
ENTM86-332G25Mn	S2.BJX02.001	WW	WW	ENTM86-332G25Mn W7HP64BWW2 N11PGV2H1GBCsk_3V3 1*2G/250/6L2.2/5R/CB_bgn_1.3C_GEs_EN11
ENTM86-334G64Mn	LX.BHP02.003	EMEA	France	ENTM86-334G64Mn W7HP64BTFR1 PARK_XT512Csk_3V3 2*2G/640/6L2.2/5R/CB_bgn_1.3C_GEs_FR51 EASYNOTE_TM86-JN-234FR
ENTM86-434G50Mn	LX.BHP02.002	EMEA	Holland	ENTM86-434G50Mn W7HP64BTNL1 PARK_XT512Csk_3V3 2*2G/500_L/6L2.2/5R/CB_bgn_1.3C_GEs_NL33 EASYNOTE_TM86-JO-010NL
ENTM86-334G32Mn	LX.BHP02.001	EMEA	UK	ENTM86-334G32Mn W7HP64BTGB1 PARK_XT512Csk_3V3 2*2G/320/6L2.2/5R/CB_bgn_1.3C_GEs_EN13 EASYNOTE_TM86-JN-010UK
ENTM86-433G32Mn	S2.BHP02.003	WW	WW	ENTM86-433G32Mn W7HP64BWW2 PARK_XT512Csk_3V3 2G+1G/320/6L2.2/5R/CB_bgn_1.3C_GEs_EN11
ENTM86-334G25Mn	S2.BHP02.002	WW	WW	ENTM86-334G25Mn W7HP64BWW2 PARK_XT512Csk_3V3 2*2G/250/BT/6L2.2/5R/CB_bgn_1.3C_GEs_EN11
ENTM86-332G16Mn	S2.BHP02.001	WW	WW	ENTM86-332G16Mn W7HP64BWW2 PARK_XT512Csk_1*2G/160/6L2.2/5R/CB_GN_1.3C_GEs_EN11
ENTM86-334G32Mn	LX.BHN02.002	EMEA	Holland	ENTM86-334G32Mn W7HP64BTNL1 UMACsk_3 2*2G/320/6L2.2/5R/CB_bgn_1.3C_GEs_NL33 EASYNOTE_TM86-GN-005NL
ENTM86-334G50Mn	LX.BHN02.001	EMEA	UK	ENTM86-334G50Mn W7HP64BTGB1 UMACsk_3 2*2G/500_L/6L2.2/5R/CB_bgn_1.3C_GEs_EN13 EASYNOTE_TM86-GN-005UK
ENTM86-332G16Mn	S2.BHN02.002	WW	WW	ENTM86-332G16Mn W7HP64BWW2 UMACss 2*1G/160/BT/6L2.2/5R/CB_bgn_1.3C_GEs_EN11
ENTM86-332G16Mn	S2.BHN02.001	WW	WW	ENTM86-332G16Mn W7HP64BWW2 UMACss 1*2G/160/6L2.2/5R/CB_GN_1.3C_GEs_EN11

Model	Acer Part No	CPU	LCD	VGA Chip	VRAM 1	Memory 1	Memory 2
ENTM86-434G64Bn	LX.BJX02.002	Ci5430M	NLED15.6 WXGAG	N11PG V2H	1G-DDR3 (64*16*8)	SO2GBII I10	SO2GBIII 10
ENTM86-334G50Mn	S2.BJX02.002	Ci3330M	NLED15.6 WXGAG	N11PG V2H	1G-DDR3 (64*16*8)	SO2GBII I10	SO2GBIII 10
ENTM86-434G64Mn	LX.BJX02.001	Ci5430M	NLED15.6 WXGAG	N11PG V2H	1G-DDR3 (64*16*8)	SO2GBII I10	SO2GBIII 10
ENTM86-332G25Mn	S2.BJX02.001	Ci3330M	NLED15.6 WXGAG	N11PG V2H	1G-DDR3 (64*16*8)	SO2GBII I10	N
ENTM86-334G64Mn	LX.BHP02.003	Ci3330M	NLED15.6 WXGAG	PARK_XT	512M-DDR3 (64*16*4)	SO2GBII I10	SO2GBIII 10
ENTM86-434G50Mn	LX.BHP02.002	Ci5430M	NLED15.6 WXGAG	PARK_XT	512M-DDR3 (64*16*4)	SO2GBII I10	SO2GBIII 10
ENTM86-334G32Mn	LX.BHP02.001	Ci3330M	NLED15.6 WXGAG	PARK_XT	512M-DDR3 (64*16*4)	SO2GBII I10	SO2GBIII 10
ENTM86-433G32Mn	S2.BHP02.003	Ci5430M	NLED15.6 WXGAG	PARK_XT	512M-DDR3 (64*16*4)	SO2GBII I10	SO1GBIII 10
ENTM86-334G25Mn	S2.BHP02.002	Ci3330M	NLED15.6 WXGAG	PARK_XT	512M-DDR3 (64*16*4)	SO2GBII I10	SO2GBIII 10
ENTM86-332G16Mn	S2.BHP02.001	Ci3330M	NLED15.6 WXGAG	PARK_XT	512M-DDR3 (64*16*4)	SO2GBII I10	N
ENTM86-334G32Mn	LX.BHN02.002	Ci3330M	NLED15.6 WXGAG	UMA	N	SO2GBII I10	SO2GBIII 10
ENTM86-334G50Mn	LX.BHN02.001	Ci3330M	NLED15.6 WXGAG	UMA	N	SO2GBII I10	SO2GBIII 10
ENTM86-332G16Mn	S2.BHN02.002	Ci3330M	NLED15.6 WXGAG	UMA	N	SO1GBII I10	SO1GBIII 10
ENTM86-332G16Mn	S2.BHN02.001	Ci3330M	NLED15.6 WXGAG	UMA	N	SO2GBII I10	N

Model	Acer Part No	Memory 3	Memory 4	HDD 1(GB)	HDD 2(GB)	ODD	Media Processor
ENTM86-434G64Bn	LX.BJX02.002	N	N	N640GB 5.4KS	N	NBDCB4XS	N
ENTM86-334G50Mn	S2.BJX02.002	N	N	N500GB 5.4KS	N	NSM8XS	N
ENTM86-434G64Mn	LX.BJX02.001	N	N	N640GB 5.4KS	N	NSM8XS	N
ENTM86-332G25Mn	S2.BJX02.001	N	N	N250GB 5.4KS	N	NSM8XS	N
ENTM86-334G64Mn	LX.BHP02.003	N	N	N640GB 5.4KS	N	NSM8XS	N
ENTM86-434G50Mn	LX.BHP02.002	N	N	N500GB 5.4KS	N	NSM8XS	N

Model	Acer Part No	Memory 3	Memory 4	HDD 1(GB)	HDD 2(GB)	ODD	Media Processor
ENTM86-334G32Mn	LX.BHP02.001	N	N	N320GB 5.4KS	N	NSM8XS	N
ENTM86-433G32Mn	S2.BHP02.003	N	N	N320GB 5.4KS	N	NSM8XS	N
ENTM86-334G25Mn	S2.BHP02.002	N	N	N250GB 5.4KS	N	NSM8XS	N
ENTM86-332G16Mn	S2.BHP02.001	N	N	N160GB 5.4KS	N	NSM8XS	N
ENTM86-334G32Mn	LX.BHN02.002	N	N	N320GB 5.4KS	N	NSM8XS	N
ENTM86-334G50Mn	LX.BHN02.001	N	N	N500GB 5.4KS	N	NSM8XS	N
ENTM86-332G16Mn	S2.BHN02.002	N	N	N160GB 5.4KS	N	NSM8XS	N
ENTM86-332G16Mn	S2.BHN02.001	N	N	N160GB 5.4KS	N	NSM8XS	N

Model	Acer Part No	Extra SW1	Card Reader	Wireless LAN1	Bluetooth	VOIP Phone	Finger Print
ENTM86-434G64Bn	LX.BJX02.002	NIS	5 in 1- Build in	3rd WiFi 2x2 BGN	N	N	N
ENTM86-334G50Mn	S2.BJX02.002	NIS	5 in 1- Build in	3rd WiFi 2x2 BGN	BT 2.1	N	N
ENTM86-434G64Mn	LX.BJX02.001	NIS	5 in 1- Build in	3rd WiFi 2x2 BGN	N	N	N
ENTM86-332G25Mn	S2.BJX02.001	NIS	5 in 1- Build in	3rd WiFi 2x2 BGN	N	N	N
ENTM86-334G64Mn	LX.BHP02.003	NIS	5 in 1- Build in	3rd WiFi 2x2 BGN	N	N	N
ENTM86-434G50Mn	LX.BHP02.002	NIS	5 in 1- Build in	3rd WiFi 2x2 BGN	N	N	N
ENTM86-334G32Mn	LX.BHP02.001	NIS	5 in 1- Build in	3rd WiFi 2x2 BGN	N	N	N
ENTM86-433G32Mn	S2.BHP02.003	NIS	5 in 1- Build in	3rd WiFi 2x2 BGN	N	N	N
ENTM86-334G25Mn	S2.BHP02.002	NIS	5 in 1- Build in	3rd WiFi 2x2 BGN	BT 2.1	N	N
ENTM86-332G16Mn	S2.BHP02.001	NIS	5 in 1- Build in	3rd WiFi 2x2 BGN	N	N	N
ENTM86-334G32Mn	LX.BHN02.002	NIS	5 in 1- Build in	3rd WiFi 2x2 BGN	N	N	N
ENTM86-334G50Mn	LX.BHN02.001	NIS	5 in 1- Build in	3rd WiFi 2x2 BGN	N	N	N
ENTM86-332G16Mn	S2.BHN02.002	NIS	5 in 1- Build in	3rd WiFi 2x2 BGN	BT 2.1	N	N
ENTM86-332G16Mn	S2.BHN02.001	NIS	5 in 1- Build in	3rd WiFi 2x2 BGN	N	N	N

Packard Bell EasyNote TM87

Model	Acer Part No	RO	Country	Description
ENTM87-434G64Bn	S2.BJY02.002	WW	WW	ENTM87-434G64Bn W7HP64BWW2 N11PGV2H1GBCrk_3V3 2*2G/640/BT/6L2.2/5R/CB_bgn_1.3C_GEr_EN11
ENTM87-334G32Mn	LX.BJY02.001	EMEA	France	ENTM87-334G32Mn W7HP64BTFR1 N11PGV2H1GBCrk_3V3 2*2G/320/BT/6L2.2/5R/CB_bgn_1.3C_GEr_FR51 EASYNOTE_TM87-CP-200FR
ENTM87-332G32Mn	S2.BJY02.001	WW	WW	ENTM87-332G32Mn W7HP64BWW2 N11PGV2H1GBCrk_3V3 1*2G/320/6L2.2/5R/CB_bgn_1.3C_GEr_EN11
ENTM87-434G50Mn	LX.BJ002.003	EMEA	Holland	ENTM87-434G50Mn W7HP64BTNL1 PARK_XT512Crk_3V3 2*2G/500_L/6L2.2/5R/CB_bgn_1.3C_GEr_NL33 EASYNOTE_TM87-JO-010NL
ENTM87-334G50Mn	LX.BJ002.002	EMEA	France	ENTM87-334G50Mn W7HP64BTFR1 PARK_XT512Crk_3V3 2*2G/500_L/6L2.2/5R/CB_bgn_1.3C_GEr_FR51 EASYNOTE_TM87-CP-205FR
ENTM87-333G25Bn	S2.BJ002.001	WW	WW	ENTM87-333G25Bn W7HP64BWW2 PARK_XT512Crk_3V3 1G+2G/250/6L2.2/5R/CB_bgn_1.3C_GEr_EN11
ENTM87-524G50Mn	LX.BJ002.001	EMEA	France	ENTM87-524G50Mn W7HP64BTFR1 PARK_XT512Crk_3V3 2*2G/500_L/BT/6L2.2/5R/CB_bgn_1.3C_GEr_FR51 EASYNOTE_TM87-ZZ-000FR
ENTM87-332G16Mn	S2.BJ00C.001	WW	WW	ENTM87-332G16Mn LINPUSBWW2 PARK_XT512Crr 1*2G/160/6L2.2/5R/CB_bgn_1.3C_GEr_EN12
ENTM87-334G32Mn	LX.BHY02.001	EMEA	Holland	ENTM87-334G32Mn W7HP64BTNL1 UMACrk_3 2*2G/320/6L2.2/5R/CB_bgn_1.3C_GEr_NL33 EASYNOTE_TM87-GN-005NL
ENTM87-332G16Mn	S2.BHY0C.001	WW	WW	ENTM87-332G16Mn LINPUSBWW2 UMACrr 1*2G/160/6L2.2/5R/CB_bgn_1.3C_GEr_EN11

Model	Acer Part No	CPU	LCD	VGA Chip	VRAM 1	Memory 1	Memory 2
ENTM87-434G64Bn	S2.BJY02.002	Ci5430M	NLED15.6 WXGAG	N11P GV2H	1G-DDR3 (64*16*8)	SO2GBI II10	SO2GBIII 10
ENTM87-334G32Mn	LX.BJY02.001	Ci3330M	NLED15.6 WXGAG	N11P GV2H	1G-DDR3 (64*16*8)	SO2GBI II10	SO2GBIII 10
ENTM87-332G32Mn	S2.BJY02.001	Ci3330M	NLED15.6 WXGAG	N11P GV2H	1G-DDR3 (64*16*8)	SO2GBI II10	N
ENTM87-434G50Mn	LX.BJ002.003	Ci5430M	NLED15.6 WXGAG	PARK_XT	512M-DDR3 (64*16*4)	SO2GBI II10	SO2GBIII 10
ENTM87-334G50Mn	LX.BJ002.002	Ci3330M	NLED15.6 WXGAG	PARK_XT	512M-DDR3 (64*16*4)	SO2GBI II10	SO2GBIII 10

Model	Acer Part No	CPU	LCD	VGA Chip	VRAM 1	Memory 1	Memory 2
ENTM87-333G25Bn	S2.BJ002.001	Ci3330M	NLED15.6 WXGAG	PARK_XT	512M-DDR3 (64*16*4)	SO1GBI I110	SO2GBIII 10
ENTM87-524G50Mn	LX.BJ002.001	Ci5520M	NLED15.6 WXGAG	PARK_XT	512M-DDR3 (64*16*4)	SO2GBI I110	SO2GBIII 10
ENTM87-332G16Mn	S2.BJ00C.001	Ci3330M	NLED15.6 WXGAG	PARK_XT	512M-DDR3 (64*16*4)	SO2GBI I110	N
ENTM87-334G32Mn	LX.BHY02.001	Ci3330M	NLED15.6 WXGAG	UMA	N	SO2GBI I110	SO2GBIII 10
ENTM87-332G16Mn	S2.BHY0C.001	Ci3330M	NLED15.6 WXGAG	UMA	N	SO2GBI I110	N

Model	Acer Part No	Memory 3	Memory 4	HDD 1(GB)	HDD 2(GB)	ODD	Media Processor
ENTM87-434G64Bn	S2.BJY02.002	N	N	N640GB 5.4KS	N	NBDCB 4XS	N
ENTM87-334G32Mn	LX.BJY02.001	N	N	N320GB 5.4KS	N	NSM8X S	N
ENTM87-332G32Mn	S2.BJY02.001	N	N	N320GB 5.4KS	N	NSM8X S	N
ENTM87-434G50Mn	LX.BJ002.003	N	N	N500GB 5.4KS	N	NSM8X S	N
ENTM87-334G50Mn	LX.BJ002.002	N	N	N500GB 5.4KS	N	NSM8X S	N
ENTM87-333G25Bn	S2.BJ002.001	N	N	N250GB 5.4KS	N	NBDCB 4XS	N
ENTM87-524G50Mn	LX.BJ002.001	N	N	N500GB 5.4KS	N	NSM8X S	N
ENTM87-332G16Mn	S2.BJ00C.001	N	N	N160GB 5.4KS	N	NSM8X S	N
ENTM87-334G32Mn	LX.BHY02.001	N	N	N320GB 5.4KS	N	NSM8X S	N
ENTM87-332G16Mn	S2.BHY0C.001	N	N	N160GB 5.4KS	N	NSM8X S	N

Model	Acer Part No	Extra SW1	Card Reader	Wireless LAN1	Bluetooth	VOIP Phone
ENTM87-434G64Bn	S2.BJY02.002	NIS	5 in 1-Build in	3rd WiFi 2x2 BGN	BT 2.1	N
ENTM87-334G32Mn	LX.BJY02.001	NIS	5 in 1-Build in	3rd WiFi 2x2 BGN	BT 2.1	N
ENTM87-332G32Mn	S2.BJY02.001	NIS	5 in 1-Build in	3rd WiFi 2x2 BGN	N	N
ENTM87-434G50Mn	LX.BJ002.003	NIS	5 in 1-Build in	3rd WiFi 2x2 BGN	N	N

Model	Acer Part No	Extra SW1	Card Reader	Wireless LAN1	Bluetooth	VOIP Phone
ENTM87-334G50Mn	LX.BJ002.002	NIS	5 in 1-Build in	3rd WiFi 2x2 BGN	N	N
ENTM87-333G25Bn	S2.BJ002.001	NIS	5 in 1-Build in	3rd WiFi 2x2 BGN	N	N
ENTM87-524G50Mn	LX.BJ002.001	NIS	5 in 1-Build in	3rd WiFi 2x2 BGN	BT 2.1	N
ENTM87-332G16Mn	S2.BJ00C.001	N	5 in 1-Build in	3rd WiFi 2x2 BGN	N	N
ENTM87-334G32Mn	LX.BHY02.001	NIS	5 in 1-Build in	3rd WiFi 2x2 BGN	N	N
ENTM87-332G16Mn	S2.BHY0C.001	N	5 in 1-Build in	3rd WiFi 2x2 BGN	N	N

Packard Bell EasyNote TM89

Model	Acer Part No	RO	Country	Description
ENTM89-522G16Mn	S2.BJZ02.001	WW	WW	ENTM89-522G16Mn W7HP64BWW2 N11PGV2H1GBCbk_3V3 1*2G/160/6L2.2/5R/CB_bgn_1.3C_GEb_EN11
ENTM89-332G16Mn	S2.BJ302.001	WW	WW	ENTM89-332G16Mn W7HP64BWW2 PARK_XT512Cbb 1*2G/160/6L2.2/5R/CB_bgn_1.3C_GEb_EN11
ENTM89-433G50Bn	S2.BJ202.002	WW	WW	ENTM89-433G50Bn W7HP64BWW2 UMACbk_3 1G+2G/500_L/6L2.2/5R/CB_bgn_1.3C_GEb_EN11
ENTM89-433G50Bn	S2.BJ202.003	WW	WW	ENTM89-433G50Bn W7HP64BWW2 UMACbk_3 2G+1G/500_L/6L2.2/5R/CB_bgn_1.3C_GEb_EN11
ENTM89-332G16Mn	S2.BJ202.001	WW	WW	ENTM89-332G16Mn W7HP64BWW2 UMACbb 1*2G/160/6L2.2/5R/CB_bgn_1.3C_GEb_EN11

Model	Acer Part No	RO	CPU	LCD	VGA Chip	VRAM 1	Memory 1
ENTM89-522G16Mn	S2.BJZ02.001	WW	Ci5520M	NLED15.6 WYGAG	N11PGV 2H	1G-DDR3 (64*16*8)	SO2GBIII 10
ENTM89-332G16Mn	S2.BJ302.001	WW	Ci3330M	NLED15.6 WYGAG	PARK_X T	512M-DDR3 (64*16*4)	SO2GBIII 10
ENTM89-433G50Bn	S2.BJ202.002	WW	Ci5430M	NLED15.6 WYGAG	UMA	N	SO1GBIII 10
ENTM89-433G50Bn	S2.BJ202.003	WW	Ci5430M	NLED15.6 WYGAG	UMA	N	SO2GBIII 10
ENTM89-332G16Mn	S2.BJ202.001	WW	Ci3330M	NLED15.6 WYGAG	UMA	N	SO2GBIII 10

Model	Acer Part No	Memory 2	Memory 3	Memory 4	HDD 1(GB)	HDD 2(GB)	ODD
ENTM89-522G16Mn	S2.BJZ02.001	N	N	N	N160GB5.4 KS	N	NSM8X S
ENTM89-332G16Mn	S2.BJ302.001	N	N	N	N160GB5.4 KS	N	NSM8X S
ENTM89-433G50Bn	S2.BJ202.002	SO2GBI I10	N	N	N500GB5.4 KS	N	NBDCB 4XS
ENTM89-433G50Bn	S2.BJ202.003	SO1GBI I10	N	N	N500GB5.4 KS	N	NBDCB 4XS
ENTM89-332G16Mn	S2.BJ202.001	N	N	N	N160GB5.4 KS	N	NSM8X S

Model	Acer Part No	Extra SW1	Card Reader	Wireless LAN1	Bluetooth	VOIP Phone	Finger Print
ENTM89-522G16Mn	S2.BJZ02.001	NIS	5 in 1-Build in	3rd WiFi 2x2 BGN	N	N	N
ENTM89-332G16Mn	S2.BJ302.001	NIS	5 in 1-Build in	3rd WiFi 2x2 BGN	N	N	N
ENTM89-433G50Bn	S2.BJ202.002	NIS	5 in 1-Build in	3rd WiFi 2x2 BGN	N	N	N
ENTM89-433G50Bn	S2.BJ202.003	NIS	5 in 1-Build in	3rd WiFi 2x2 BGN	N	N	N
ENTM89-332G16Mn	S2.BJ202.001	NIS	5 in 1-Build in	3rd WiFi 2x2 BGN	N	N	N

Test Compatible Components

This computer's compatibility is tested and verified by Acer's internal testing department. All of its system functions are tested under Windows® 7 environment.

Refer to the following lists for components, adapter cards, and peripherals which have passed these tests. Regarding configuration, combination and test procedures, please refer to the Packard Bell EasyNote TM86/TM87/TM89 Compatibility Test Report released by the Acer Mobile System Testing Department.

Microsoft® Windows® 7 Environment Test

Category	Vendor	Description	PN
CPU			
Arrandale 2.13G (Ci3330M)	Intel	IC CP80617004122AG SLBMD C2 2.13G PGA988	KC.33001.DMP
Arrandale 2.26G (Ci3350M)	Intel	IC CP80617004161AC SLBPK C2 2.26G PGA988	KC.35001.DMP
Arrandale 2.26G (Ci5430M)	Intel	IC CP80617004161AD SLBPN C2 2.26G PGA988	KC.43001.DMP
Arrandale 2.4G (Ci5520M)	Intel	IC CP80617004119AE SLBNB C2 2.4G PGA988P	KC.52001.DMP
Arrandale 2.53G (Ci5540M)	Intel	IC CP80617004116AD SLBPG C2 2.53G PGA988	KC.54001.DMP
Arrandale 2.66G (Ci7620M)	Intel	IC CP80617003981AH SLBPD C2 2.66G PGA 988P	KC.62001.DMP
Q3GG C2 2.13G	Intel	CPU Intel Core i3 330M PGA 2.13G 35W Arrandale, TJ90, VT, 3M L3	KC.33001.DMP
Q3LN C2 2.26G	Intel	CPU Intel Core i3 350M PGA 2.26G 35W Arrandale, TJ90, VT, 3M L3	KC.35001.DMP
Q3LR C2 2.26G	Intel	CPU Intel Core i5 430M PGA 2.26G ARD, uP to SC 2.53G, 3M L3	KC.43001.DMP
RAM SODIMM DDR3-1G 1066			
1G DDR3- 1066	SAMSUNG	DDR3 MODU SAM M471B2873EH1-CF8 1GB/ 1066	KN.1GB0B.028
1G DDR3- 1066	ELDIPA	DDR3 MODU SAM EBJ11UE6BDS0-AE-F 1GB/ 1066	KN.1GB09.012
1G DDR3- 1066	HYNIX	DDR3 MODU HYN HMT112S6BFR6C-G7N0 1G/1066	KN.1GB0G.025
RAM SODIMM DDR3-2G 1066			
2G DDR3- 1066	MICRON	MT16JSF25664HZ-1G1F1	KN.2GB04.015
2G DDR3- 1066	SAMSUNG	DDR3 MODU SAM M471B5673EH1-CF8 2G/ 1066	KN.2GB0B.012
2G DDR3- 1066	ELDIPA	DDR3 MODU ELP EBJ21UE8BDS0-AE-F 2G/ 1066	KN.2GB09.006
2G DDR3- 1066	HYNIX	DDR3 MODU HYN HMT125S6BFR8C-G7N0 2G/1066	KN.2GB0G.014
RAM SODIMM DDR3-4G 1066			
4G DDR3- 1066	SAMSUNG	M471B5273BH1-CF8	KN.4GB0B.007
4G DDR3- 1066	ELPIDA	Memory NONE SO-DIMM DDRIII 1066 4GB dummy P/N LF	KN.4GB00.001
RAM SODIMM DDR3-1G 1333			

Category	Vendor	Description	PN
1G DDR3-1333	SAMSUNG	M471B2873FHS-CH9	KN.1GB0B.035
RAM SODIMM DDR3-2G 1333			
2G DDR3-1333	SAMSUNG	M471B5673FH0-CH9 LF	KN.2GB0B.023
RAM SODIMM DDR3-4G 1333			
4G DDR3-1333	SAMSUNG	M471B5273CH0-CH9	KN.4GB0B.010
4G DDR3-1333	ELPIDA	DDDR3 4G EBJ41UF8BAS0-DJ-F	KN.4GB09.001
LCD N15.6WXGAG			
N15.6WXG AG	AUO (70/80/90)	LCD MODU B156XW01 V2 15.6" HD G 0FA	LK.15605.014
N15.6WXG AG	CPT(70/80/90)	LCD MODU CLAA156WA01A 15.6" HD G 0FA	
N15.6WXG AG	CMO (80)	LCD MODU N156B3-L02 15.6" HD G 0FA	
N15.6WXG AG	Samsung(NE W80)	LCD MODU LTN156AT01-A01 15.6" HD G 0FA	
N15.6WXG AG	LGD(80)	LCD MODU LP156WH1-TLA3 15.6" HD G 0FA	
LCD NLED15.6WXGAG			
NLED15.6 WXGAG	AUO (70/80/90)	LCD_LED_M B156XW02 V2 156 HD G HW:4A 0FA	LK.15605.010
NLED15.6 WXGAG	CPT(70/80/90)	LCD_LED_M CLAA156WA11A 15.6" HD G 0FA	
NLED15.6 WXGAG	CMO (70/90)	LCD_LED_M N156B6-L0B 15.6" HD G 0FA	LK.1560D.010
NLED15.6 WXGAG	Samsung(NE W70/80/90)	LCD_LED_M LTN156AT02-A04 15.6" HD G	
NLED15.6 WXGAG	Samsung(NE W70/90)	LCD_LED_M LTN156AT02-A02 15.6" HD G ABO!	
NLED15.6 WXGAG	SAMSUNG	SAMSUNG 15.6"W WXGA Glare LTN156AT02-A04 LF 220nit 8ms	
NLED15.6 WXGAG	LGD(70/80/90)	LCD_LED_M LP156WH2-TLE1 15.6" HD G 0FA	LK.15608.002
NLED15.6 WXGAG	INL(70/90)	LCD_LED_M BT156GW01 V2 15.6" HD G 0FA	LK.1560N.001
HDD			
160G 5.4K rPm	SEAGATE	HDD 160G 2.75"W .37"H ST9160314AS 0FA	KH.16001.042
160G 5.4K rPm	TOSHIBA	HDD 160G .37"H MK1665GSX 0FA	KH.16004.008
160G 5.4K rPm	HGST	HDD 160G .37"H HTS545016B9A300 L/V 0FA	KH. 16007.026
160G 5.4K rPm	WD	HDD 160G .37"H WD1600BEVT-22A23T0 0FA	KH.16008.027
250G 5.4K rPm	SEAGATE	HDD 250G .37"H ST9250315AS 0FA	KH.25001.016

Category	Vendor	Description	PN
250G 5.4K rPm	TOSHIBA	HDD 250G .37"H MK2565GSX 0FA	KH.25004.005
250G 5.4K rPm	HGST	HDD 250G .37"H HTS545025B9A300 L/V 0FA	KH.25007.016
250G 5.4K rPm	WD	HDD 250G .37"H WD2500BEVT-22A23T0 0FA	KH.25008.025
320G 5.4K rPm	SEAGATE	HDD 320G 2.75"W .37"H ST9320325AS 0FA	KH.32001.017
320G 5.4K rPm	TOSHIBA	HDD 320G .37"H MK3265GSX 0FA	KH.32004.004
320G 5.4K rPm	HGST	HDD 320G .37"H HTS545032B9A300 L/V 0FA	KH.32007.008
320G 5.4K rPm	WD	HDD 320G .37"H WD3200BEVT-22A23T0 0FA	KH.32008.019
500G 5.4K rPm	SEAGATE	HDD 500G .37" ST9500325AS 0FA	KH.50001.011
500G 5.4K rPm	TOSHIBA	HDD 500G .37"H MK5065GSX 0FA	KH.50004.002
500G 5.4K rPm	HGST	HDD 500G .37"H HTS545050B9A300 L/V 0FA	KH.50007.010
500G 5.4K rPm	WD	HDD 500G .37"H WD5000BEVT-22A0RT0 0FA	KH.50008.017
640G 5.4K rPm	WD	HDD 640G .37"H WD6400BEVT-22A0RT0 0FA	KH.64008.004
ODD			
NBDCB4XS (CD-RW Ultra Speed)	HLDS	BRDVD_DRV 50G .5H CT21N KO.0040D.004 0FA	KO.0040D.004
NBDCB4XS (CD-RW Ultra Speed)	PLDS (Refresh)	BRDVD_DRV 50G DS-4E1S KO.0040F.003 0FA	KO.0040F.003
NBDCB4XS (CD-RW High Speed)	SONY	BRDVD_DRV BC-5500H-AR KO.0040E.003 0FA	
NSM8XS	TSST	TS-L633C	KU.00801.035
NSM8XS	Panasonic	DVDRW DRV UJ890ADAA-A KU.00807.070 0FA	KU.00807.070
NSM8XS	HLDS	DVDRW DRV 8X .5"H GT30N KU.0080D.048 0FA	KU.0080D.048
NSM8XS	SONY-QSI	AD-7585H	KU.0080E.027
NSM8XS	PLDS	DVDRW DRV 8X DS-8A4SH KU.0080F.006 0FA	KU.0080F.006
NSM8XS	HLDS	DVDRW DRV 8X .5"H GT30N KU.0080D.048 0FA	
VGA ChiP			
Madsion Pro	AMD	S IC 216-0772000 MADISON PRO FCBGA 0FA	KI.23200.169
Park XTM2	AMD	S IC 216-0774007 A11 PARK PRO M2 0FA	KI.23200.162

Category	Vendor	Description	PN
VRAM			
1GB	SAMSUNG	VRAM SAMSUNG GraPhic DDRIII 800 1Gb K4W1G1646E-HC12 LF	VR.1GB0B.006
1GB	HYNIX	VRAM HYNIX GraPhic DDRIII 800 1Gb H5TQ1G63BFR-12C LF	VR.1GB0G.004
1GB	AMD	VRAM ATI GraPhic DDRIII 800 1Gb 23EY2387MA12-SZ LF+HF	VR.1GB0T.002
512MB	SAMSUNG		
512MB	HYNIX		
512MB	AMD		
NB ChiPset			
PCH	INTEL	S IC BD82HM57 QMNS B3 FCBGA 1071 PCH	
PCH	INTEL	S IC BD82HM55 QMNT B3 FCBGA 1071 PCH	KI.G5501.002
PCH	INTEL	S IC BD82HM55 SLGZS B3 FCBGA 1071 PCH	KI.G5501.002
AdaPter			
65W (UMA)	DELTA	AC ADAP DELTA ADP-65JH DBA 65W 3P	AP.06501.026
65W (UMA)	LITE-ON	AC ADAP LITE-ON PA-1650-22AC 65W 3P	AP.06503.024
65W (UMA) LV5 OBL	HIPRO	AC ADAP HIPRO HP-A0652R3B 1LF 65W 3P	AP.0650A.012
90W (Discrete) LV5 OBL	DELTA	AC ADAP DELTA ADP-90CD DBA 90W 3P	AP.09001.027
90W (Discrete)	LITE-ON	AC ADAP LITEON PA-1900-34AR 90W 3P	AP.09003.021
90W (Discrete) LV5 OBL	HIPRO	AC ADAP HIPRO HP-A0904A3 B1LF 90W 3P	AP.0900A.005
Power Cord			
3Pin	Linetek	PWR CORD LP30BX1.8MXLS15 US 3P L	
3Pin	I-Sheng	PWR CORD SP305AX1.8MXIS034 SPT-2 BLK	
3Pin	WS	PWR CORD WS-001F-2X1.8MXWS-083 3P US W	
Battery			
6CELL2.2	SANYO	BATT SA SA 3S2P 4.4AH 7 0C9 0FA	BT.00603.111
6CELL2.2	SONY	BATT SY SY 3S2P 4.4AH 7 0C9 0FA	BT.00604.049
6CELL2.2	PANASONIC	BATT PA PA 3S2P 4.4AH 7 0C9 0FA	BT.00605.062
6CELL2.2	SAMSUNG	BATT SM SM 3S2P 4.4AH 7 0C9 0FA	BT.00606.008
6CELL2.2	SIMPLO (PANASONIC)	BATT SP PA 3S2P 4.4AH 7 0C9 0FA	BT.00607.125
6CELL2.2	SIMPLO (LGC)	BATT SP LG 3S2P 4.4AH 7 0C9 0FA	BT.00607.126
6CELL2.2	SIMPLO (SAMSUNG)	BATT SP SM 3S2P 4.4AH 7 0C9 0FA	BT.00607.127
K/B			
	DARFON	KB 9J.N1H82 DARFON INT'E 09F	KB.I170E.001
	Chicony	KB MP-09B2 CHICONY INT'E 09F	

Category	Vendor	Description	PN
	Sunrex	KB V104702 SUNREX INT'E 09F	
	DARFON (NEW90)	KB 9Z.N1H82 DARFON INT'E 0C8 GP8T	
	Chicony (NEW90)	KB MP-09B2 CHICONY INT'E 0C8 GP8T	
	Sunrex (NEW90)	KB V104702 SUNREX INT'E 0C8 GP8T	
Touch Pad			
MULTI	SYNAPTICS	TRACK PAD SYNAPTICS TM-01146-005 MULTI	
MULTI	ALPS	TRACK PAD ALPS KGDF0026A MULTI-FINGER	
MULTI	ELANTECH	TOUCH PAD ELANTECH S8442D-5100	
Hinge			
LCD_BRK_L_156_ASSY	SZS	NEW70_LCD_BRK_L_156_ASSY	
LCD_BRK_L_156_ASSY	GANGYI	NEW70_LCD_BRK_L_156_ASSY	
LCD_BRK_L_156_ASSY	WANHE	NEW70_LCD_BRK_L_156_ASSY	
LCD_BRK_R_156_ASSY	SZS	NEW70_LCD_BRK_R_156_ASSY	
LCD_BRK_R_156_ASSY	GANGYI	NEW70_LCD_BRK_R_156_ASSY	
LCD_BRK_R_156_ASSY	WANHE	NEW70_LCD_BRK_R_156_ASSY	
LED_BRK_L_156_ASSY	SZS	NEW70_LED_BRK_L_156_ASSY	
LED_BRK_L_156_ASSY	GANGYI	NEW70_LED_BRK_L_156_ASSY	
LED_BRK_L_156_ASSY	WANHE	NEW70_LED_BRK_L_156_ASSY	
LED_BRK_R_156_ASSY	SZS	NEW70_LED_BRK_R_156_ASSY	
LED_BRK_R_156_ASSY	GANGYI	NEW70_LED_BRK_R_156_ASSY	
LED_BRK_R_156_ASSY	WANHE	NEW70_LED_BRK_R_156_ASSY	

Category	Vendor	Description	PN
LCD_BRK_L_156_ASSY	SZS	NEW80_LCD_BRK_L_156_ASSY	
LCD_BRK_L_156_ASSY	LH	NEW80_LCD_BRK_L_156_ASSY	
LCD_BRK_L_156_ASSY	CHAOLI	NEW80_LCD_BRK_L_156_ASSY	
LCD_BRK_L_156_ASSY	S.H.	NEW80_LCD_BRK_L_156_ASSY	
LCD_BRK_R_156_ASSY	SZS	NEW80_LCD_BRK_R_156_ASSY	
LCD_BRK_R_156_ASSY	LH	NEW80_LCD_BRK_R_156_ASSY	
LCD_BRK_R_156_ASSY	CHAOLI	NEW80_LCD_BRK_R_156_ASSY	
LCD_BRK_R_156_ASSY	S.H.	NEW80_LCD_BRK_R_156_ASSY	
LED_BRK_L_156_ASSY	SZS	NEW80_LED_BRK_L_156_ASSY	
LED_BRK_L_156_ASSY	LH	NEW80_LED_BRK_L_156_ASSY	
LED_BRK_L_156_ASSY	CHAOLI	NEW80_LED_BRK_L_156_ASSY	
LED_BRK_L_156_ASSY	S.H.	NEW80_LED_BRK_L_156_ASSY	
LED_BRK_R_156_ASSY	SZS	NEW80_LED_BRK_R_156_ASSY	
LED_BRK_R_156_ASSY	LH	NEW80_LED_BRK_R_156_ASSY	
LED_BRK_R_156_ASSY	CHAOLI	NEW80_LED_BRK_R_156_ASSY	
LED_BRK_R_156_ASSY	S.H.	NEW80_LED_BRK_R_156_ASSY	
LCD_BRK_L_156_ASSY	SZS	NEW90_LCD_BRK_L_156_ASSY	

Category	Vendor	Description	PN
LCD_BRK_L_156_ASSY	SH	NEW90_LCD_BRK_L_156_ASSY	
LCD_BRK_L_156_ASSY	LH	NEW90_LCD_BRK_L_156_ASSY	
LCD_BRK_R_156_ASSY	SZS	NEW90_LCD_BRK_R_156_ASSY	
LCD_BRK_R_156_ASSY	SH	NEW90_LCD_BRK_R_156_ASSY	
LCD_BRK_R_156_ASSY	LH	NEW90_LCD_BRK_R_156_ASSY	
LED_BRK_L_156_ASSY	SZS	NEW90_LED_BRK_L_156_ASSY	
LED_BRK_L_156_ASSY	SH	NEW90_LED_BRK_L_156_ASSY	
LED_BRK_L_156_ASSY	LH	NEW90_LED_BRK_L_156_ASSY	
LED_BRK_R_156_ASSY	SZS	NEW90_LED_BRK_R_156_ASSY	
LED_BRK_R_156_ASSY	SH	NEW90_LED_BRK_R_156_ASSY	
LED_BRK_R_156_ASSY	LH	NEW90_LED_BRK_R_156_ASSY	
3G card			
	HUAWEI	W/LAN_3G 07A EM770W 7.2MBPS 0FA	
	Ericsson	W/W F3307 KRD 131 16/02 7.2M GSM900 0FA	
WLAN Card			
Mini-card WLAN (3rd WiFi 1x2 BGN)	Foxconn (Atheros)	W/L CARD 086 T77H047.31 150MBPS HB93	NI.23600.062
Mini-card WLAN (3rd WiFi 1x2 BGN)_New 75/85	Liteon	W/L CARD 07P B853GN900G 54MBPS HB93	
Mini-card WLAN (3rd WiFi 1x2 BGN)	Foxconn	W/L _ T77H103.00 300MBPS BCM943225HM	NI.23600.066

Category	Vendor	Description	PN
Mini-card WLAN (3rd WiFi BG) (NEW70)	Foxconn (NEW70)	W/L CARD 085 T77H121.01 54MBPS HB95	NI.23600.047
Mini-card WLAN (3rd WiFi 2x2 BGN)	FOXCONN TW	W/L CARD 086 T77H047.31 150MBPS HB93	NI.23600.062
Mini-card WLAN (3rd WiFi 2x2 BGN)	LITE-ON	W/L WN6602AH-AA B853GU210G 300M HB93V046	NI.23600.063
Mini-card WLAN (3rd WiFi 2x2 BGN)	LITE-ON W/L	WN6603LH-AA B853GZ600D RTL8192SE	NI.23600.065
Mini-card WLAN (3rd WiFi BG)	FOXCONN TW	Foxconn Wirelss LAN Atheros HB95 1x1 BG (HM)	NI.23600.047
INTEL Conder Peak		W/L 112BNHMMW _ 300M CONDOR PEAK1X2 0FA	
PLM00010 QMI HB93		W/L CARD 086 EM306-AR 300MBPS HB93	
	Intel	622ANXHMW _ intel 6250	
	Foxconn	Foxconn T77H121.10 HB95	
	Foxconn	Foxconn T77H167.07 HB97	
Antenna			
Antenna WIFI/ WIMAX L	WNC	ANTENNA 0C6 81.EJT15.GEE WIFI AUX/L	
Antenna WIFI/ WIMAX R	WNC	ANTENNA 0C6 81.EJT15.GED WIFI M R	
Antenna 3G main+WIFI aux	WNC	ANTENNA 0C6 81.EJT15.GEB 3G M/WIFI A	
Antenna 3G aux+WIFI main+GPS	WNC	ANTENNA 0C6 81.EJT15.GEC 3G A/WIFI M/G	
Antenna WIFI/ WIMAX L	WNC	ANTENNA 0C7 81.EJT15.GEJ WIFI A/L	
Antenna WIFI/ WIMAX R	WNC	ANTENNA 0C7 81.EJT15.GEH WIFI M/R	
Antenna 3G main+WIFI aux	WNC	ANTENNA 0C7 81.EJT15.GEF 3G M/WIFI A	
Antenna 3G aux+WIFI main+GPS	WNC	ANTENNA 0C7 81.EJT15.GEG 3G A/WIFI M/G	

Category	Vendor	Description	PN
Antenna WIFI/ WIMAX L	WNC	ANTENNA 0C8 81.EJT15.GEN WIFI A/L	
Antenna WIFI/ WIMAX R	WNC	ANTENNA 0C8 81.EJT15.GEM WIFI M/R	
X	WNC	ANTENNA 0C8 81.EJT15.GEK 3G M/WIFI A	
Antenna 3G aux+WIFI main+GPS	WNC	ANTENNA 0C8 81.EJT15.GEL 3G A/WIFI M/G	
Blue Tooth			
BT	Foxconn	B_T_ MODU 0C9 FOXCONN T77H114.01 BCM2070	BT.21100.005
BT	Foxconn	Foxconn Bluetooth BRM 2046 BT2.1 (T60H928.33) FW:861	BT.21100.004
BT	Foxconn	B_T_ MODU 085 FOXCONN T77H056.00 AR3011	
Camera			
1.3M	Chicony	CH9665SN (CNF9157)	AM.21400.067
1.3M	Suyin CAMERA	M HF1315-S32B-OV01 SUYIN 1.3M	AM.21400.068
1.3M	Liteon	LT9665AL (09P2SF119)	AM.21400.069
DC-IN Jack			
		65W	
		65W	
		65W	
		90W	
		90W	
		90W	
Wire Set			
MIC		MIC SET 0CB 6D H2.2 -42DB 1MIC	
MIC	Kingstate	MIC SET 0CB 6D H2.2 -42DB 1MIC	
MIC	Fujikon	MIC SET 0CB 6D H2.2 -42DB 1MIC	
CCFL	MEC	H-CONN SET 0C9 CCFL LCD-M/B W/CAMERA	
CCFL	High-Tek		
CCFL With 3G	MEC	H-CONN SET 0C9 CCFL LCD-M/B W/CAMERA	
	High-Tek		
CCFL w/o CMOS	MEC	H-CONN SET 0C9 CCFL LCD-M/B W/O CAMERA	
	High-Tek		
CCFL w/o CMOS With 3G	MEC	H-CONN SET 0C9 CCFL LCD-M/B W/O CAMERA	
	High-Tek		
LED	MEC	H-CONN SET 0C9 LED LCD-M/B W/CAMERA	

Category	Vendor	Description	PN
LED 2nd source(IPE X compatible)	"MEC,HIGH-TEK,Foxconn		
"H-CONN SET 0C9 LED LCD-M/B W/ CAMERA 2nd source(IPE X compatible)			
LED w/o CMOS	MEC	H-CONN SET 0C9 LED LCD-M/B W/O CAMERA	
"LED w/o CMOS			
""MEC			
"H-CONN SET 0C9 LED LCD-M/B W/O CAMERA			
LED With 3G	MEC	H-CONN SET 0C9 LED LCD-MB W/CAM W/3G H_C	
"LED With 3G			
""MEC			
"H-CONN SET 0C9 LED LCD-MB W/CAM W/3G H_C			
LED w/o CMOS With 3G	MEC	H-CONN SET 0C9 LED LCD-MB WOCAM W/ 3G H_C	
"LED w/o CMOS With 3G			
""MEC			
"H-CONN SET 0C9 LED LCD-MB WOCAM W/3G H_C			
3G			
	MEC	H-CONN SET 0C9 M/B-3G/B	
	High-Tek	H-CONN SET 0C9 M/B-3G/B	
	Foxconn	H-CONN SET 0C9 M/B-3G/B	
BT			
	MEC	H-CONN SET 0C9 M/B-BT	

Category	Vendor	Description	PN
	High-Tek	H-CONN SET 0C9 M/B-BT	
	Foxconn	H-CONN SET 0C9 M/B-BT	
CardRead/B			
	Humburg	FFC 8P H P1 PAD=0.7 187MM CARD READER/ B-M/B	
	Cvilux	FFC 8P H P1 PAD=0.7 187MM CARD READER/ B-M/B	
TP-M/B			
	Humburg	FFC 6P G P1 PAD=0.65 116MM TP-M/B	
	Cvilux	FFC 6P G P1 PAD=0.65 116MM TP-M/B	
USB-M/B			
	Humburg	FFC 12P H P1 PAD=0.7 192MM USB-M/B	
	Cvilux	FFC 12P H P1 PAD=0.7 192MM USB-M/B	
POWER/B-M/B			
	Humburg	FFC 10P H P1 PAD=0.6 89MM POWER/B-M/B	
	Cvilux	FFC 10P H P1 PAD=0.6 89MM POWER/B-M/B	
	Humburg	FFC 10P H P1 PAD=0.6 89MM POWER/B-M/B	
	Cvilux	FFC 10P H P1 PAD=0.6 89MM POWER/B-M/B	
	Humburg	FFC 10P H P1 PAD=0.6 174MM POWER/B-M/B	
	Cvilux	FFC 10P H P1 PAD=0.6 174MM POWER/B-M/B	
LID/B-M/B			
	Humburg	FFC 4P H P1 PAD=0.7 32MM SW/B-M/B	
	Cvilux	FFC 4P H P1 PAD=0.7 32MM SW/B-M/B	
	Humburg	FFC 4P H P1 PAD=0.65 34.85MM SW/B-M/B	
	Cvilux	FFC 4P H P1 PAD=0.65 34.85MM SW/B-M/B	
	Humburg	FFC 4P H P1 PAD=0.6 64.27MM SW/B-M/B	
	Cvilux	FFC 4P H P1 PAD=0.6 64.27MM SW/B-M/B	
Inverter			
	Darfon	INVERTER 06G 15-17 VK.21071.804 DARF MPS	
	YEC	INVERTER 06G 15-17 YNV-C01AC YEC MPS	
	YEC	INVERTER 06G 15-17 YNV-C01AC YEC MPS	
	Sumida		
SPEAKER			
SPK-R	Zylux	SPK PACK 0CB 2W 4OHM MAIN SPEAKER R	
SPK-R	Galax	SPK PACK 0CB 2W 4OHM MAIN SPEAKER R	
SPK-R	NJL	SPK PACK 0CB 2W 4OHM MAIN SPEAKER R	
SPK-L	Zylux	SPK PACK 0CB 2W 4OHM MAIN SPEAKER L	
SPK-L	Galax	SPK PACK 0CB 2W 4OHM MAIN SPEAKER L	
SPK-L	NJL	SPK PACK 0CB 2W 4OHM MAIN SPEAKER L	
MIC			
	Fujikon	MIC SET 0CB 6D H2.2 -42DB 1MIC	
	Kingstate	MIC SET 0CB 6D H2.2 -42DB 1MIC	
	Xing-Meng	MIC SET 0CB 6D H2.2 -42DB 1MIC	

Category	Vendor	Description	PN
Thermal Module (UMA)			
CCI	Delta	NEW70_UMA_THM_MAIN_ASSY_Delta_CCI	
CCI	ADDA	NEW70_UMA_THM_MAIN_ASSY_ADDA_CCI	
Robin	Delta	NEW70_UMA_THM_MAIN_ASSY_Delta_ROBIN	
Robin	ADDA	NEW70_UMA_THM_MAIN_ASSY_ADDA_ROBIN	
AVC	Delta	NEW70_UMA_THM_MAIN_ASSY_Delta_AVC	
AVC	ADDA	NEW70_UMA_THM_MAIN_ASSY_ADDA_AVC	
Sunon	Sunon	NEW70_UMA_THM_MAIN_ASSY_SUNON_SUNON	
CCI	Delta	NEW70_PARK_THM_MAIN_ASSY_Delta_CCI	
CCI	ADDA	NEW70_PARK_THM_MAIN_ASSY_ADDA_CCI	
Robin	Delta	NEW70_PARK_THM_MAIN_ASSY_Delta_ROBIN	
Robin	ADDA	NEW70_PARK_THM_MAIN_ASSY_ADDA_ROBIN	
AVC	Delta	NEW70_PARK_THM_MAIN_ASSY_Delta_AVC	
AVC	ADDA	NEW70_PARK_THM_MAIN_ASSY_ADDA_AVC	
Sunon	Sunon	NEW70_PARK_THM_MAIN_ASSY_SUNON_SUNON	
CCI	Delta	NEW70_MADISON_THM_MAIN_ASSY_Delta_CCI	
CCI	ADDA	NEW70_MADISON_THM_MAIN_ASSY_ADDA_CCI	
Robin	Delta	NEW70_MADISON_THM_MAIN_ASSY_Delta_ROBIN	
Robin	ADDA	NEW70_MADISON_THM_MAIN_ASSY_ADDA_ROBIN	
AVC	Delta	NEW70_MADISON_THM_MAIN_ASSY_Delta_AVC	
AVC	ADDA	NEW70_MADISON_THM_MAIN_ASSY_ADDA_AVC	
Sunon	Sunon	NEW70_MADISON_THM_MAIN_ASSY_SUNON_SUNON	
Core Logic			
CLK GEN	SILEGO	S IC SLG8SP626VTR QFN 72P CLK GEN	
GbE LAN	BROADCOM	S IC BCM57780A1KMLG QFN 48P E-LAN CTRL	
EC	ENE	S IC KB926QFD3 LQFP 128P KB CONTROL	
Card Reader Controller	ENE	S IC UB6250NF A1-110 QFN 32P CARD READER	
BIOS	MXIC	S IC FL 16M MX25L1605DM2I-12G SOP 8P ROM	

Category	Vendor	Description	PN
Thermal Sensor	ADI	S IC ADM1032ARMZ MSOP 8P TEMP SENSOR	
HD Audio codec	REALTEK	S IC ALC272X-GR LQFP 48P CODEC	
Audio Amplifier	TI	S IC TPA6017A2PWPR TSSOP 20P AMP	
FAN controller	ANPEC	S IC APL5607KI-TRG SOP 8P	

Online Support Information

This section describes online technical support services available to help you repair your Acer Systems.

If you are a distributor, dealer, ASP or TPM, please refer your technical queries to your local Acer branch office. Acer Branch Offices and Regional Business Units may access our website. However some information sources will require a user i.d. and password. These can be obtained directly from Acer CSD Taiwan.

Acer's Website offers you convenient and valuable support resources whenever you need them.

In the Technical Information section you can download information on all of Acer's Notebook, Desktop and Server models including:

- Service guides for all models
- User's manuals
- Bios updates
- Software utilities
- Spare parts lists
- TABs (Technical Announcement Bulletin)

For these purposes, we have included an Acrobat File to facilitate the problem-free downloading of our technical material.

Also contained on this website are:

- Detailed information on Acer's International Traveler's Warranty (ITW)
- Returned material authorization procedures
- An overview of all the support services we offer, accompanied by a list of telephone, fax and email contacts for all your technical queries.

We are always looking for ways to optimize and improve our services, so if you have any suggestions or comments, please do not hesitate to communicate these to us.

A

- AFLASH Utility 32
- Antennas
 - Removing 96, 98
 - Replacing 100

B

- Battery
 - Replacing 138
- Battery Pack
 - Removing 45
- BIOS
 - ROM type 16
 - vendor 16
- BIOS Utility 23–32
 - Advanced 27
 - Boot 30
 - Exit 31
 - Navigating 23
 - Onboard Device Configuration 28
 - Power 30
 - Save and Exit 31
 - Security 27
 - System Security 31
- Board Layout
 - Top View 159

C

- Camera Module
 - Removing 89, 90
 - Replacing 103, 105, 106, 107, 109
- Common Problems 140
- computer
 - on indicator 10
- CPU
 - Removing 83
 - Replacing 112

D

- DIMM Modules
 - Replacing 131
- Display 5
- display
 - hotkeys 14

E

- EasyTouch Failure 150
- External Module Disassembly
 - Flowchart 44

F

- Features 1
- Flash Utility 32
- FPC Cable
 - Removing 94
- FRU (Field Replaceable Unit) List 165

H

- Hard Disk Drive
 - Removing 56
 - Replacing 129
- HDTV Switch Failure 151
- Hibernation mode
 - hotkey 14
- Hot Keys 12

I

- Indicators 10
- Intermittent Problems 152
- Internal Microphone Failure 145
- Internal Speaker Failure 144

J

- Jumper and Connector Locations 159

K

- Keyboard
 - Removing 60
 - Replacing 128
- Keyboard Failure 143

L

- LCD Bezel
 - Replacing 108
- LCD Brackets
 - Removing 94

- Replacing 102
- LCD Cable
 - Replacing 102
- LCD Failure 143
- LCD Module Disassembly
 - Flowchart 84
- LCD Module Reassembly Procedure 100
- LCD Panel
 - Removing 92
 - Replacing 102
- Left Speaker Module
 - Removing 66
 - Replacing 124

M

- Main Unit Disassembly
 - Flowchart 58
- Mainboard
 - Removing 72, 74, 76, 77
 - Replacing 114
- media access
 - on indicator 10
- Memory
 - Replacing 131
- Memory Check 140
- Model Definition 178

N

- No Display Issue 141

O

- ODD Failure 147
- Online Support Information 201
- Optical Disk Drive
 - Replacing 132, 134, 135
- Optical Drive Module
 - Removing 48

P

- Panel 6
 - Bottom 9
- PC Card 10
- Power On Failure 140

R

- Replacing 122, 124
- Right Speaker Module
 - Removing 67
 - Replacing 122

S

- SD Dummy Card
 - Removing 46, 47
 - Replacing 136, 137
- Speakers 122, 124
 - Removing 66, 67
- System
 - Block Diagram 5

T

- Test Compatible Components 187
- Thermal Module
 - Removing 81
 - Replacing 113
- Thermal Unit Failure 150
- TouchPad
 - Removing 70
- TouchPad Bracket
 - Removing 70
 - Replacing 120, 123
- TouchPad Failure 144
- Troubleshooting
 - Built-in KB Failure 143
 - EasyTouch Buttons 150
 - HDTV Switch 151
 - Internal Microphone 145
 - Internal Speakers 144
 - LCD Failure 143
 - No Display 141
 - ODD 147
 - Other Failures 151
 - Power On 140
 - Thermal Unit 150
 - TouchPad 144
 - WLAN 150

U

- Undetermined Problems 152
- Upper Cover
 - Removing 62
 - Replacing 125
- utility

W

Windows 2000 Environment Test 188

Wireless Function Failure 150

WLAN Module

 Removing 54

 Replacing 130

